

Thermal Management Solutions

Cooling Units • Air/Water Heat Exchangers • Chillers
Filterfans® • Heaters, Thermostats and Hygrostats

Main Catalog • Edition 11

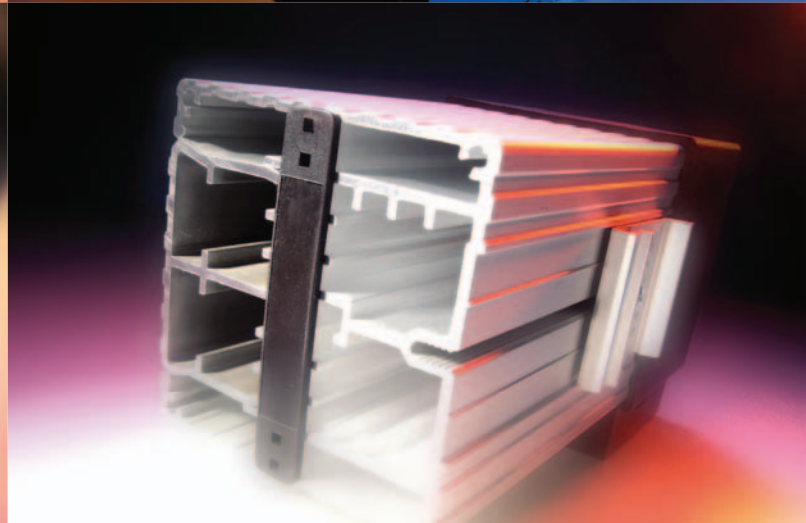
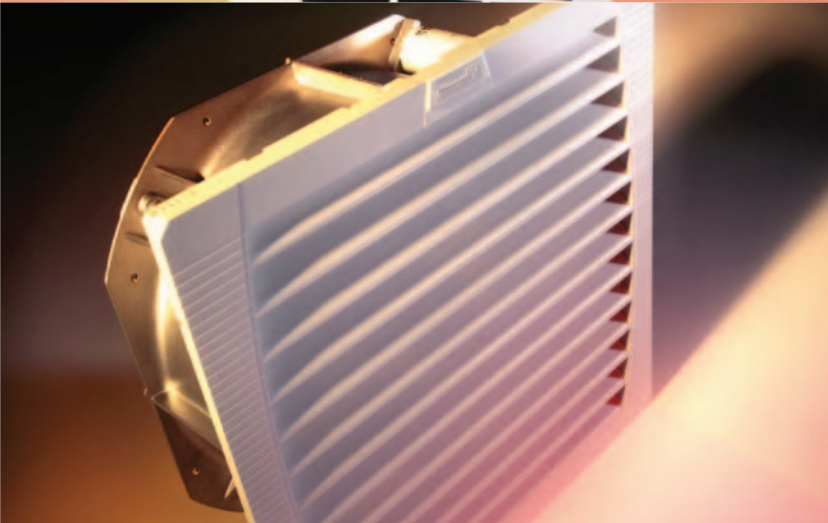

SHARING
COMPETENCE | 

Pfannenberg
ELECTRO-TECHNOLOGY FOR INDUSTRY







Thermal Protection for Critical Electronics

DTS 3000, DTT 6000 and DTI 9000 Series Cooling Units

Utilize closed loop cooling in tough industrial or outdoor applications with Pfannenberg's 'service-friendly' cooling units.

Our DTS 3000 Series is driven to meet the demands of our North American NEMA market. These units meet the needs on indoor NEMA Type 12 applications, NEMA 3R/4 outdoor applications and NEMA Type 4/4x stainless steel for washdown applications.

An absolute world innovation: the DTT Series. The 6000 Series top mounted cooling units offer unique security through the innovative, patented condensate management system and it is installable in the most limited of spaces.

The DTI 9000 Series allows for European-style recessed mounting on enclosure doors and/or side panels on modular systems. These "click & fit" units reduce installation times by half.

DTT Top Mounted Cooling Units

Featuring a unique, patented condensate management system which prevents all condensate from penetrating into the electrical enclosure. The very small installation size also means that you can install your electrical enclosures in a row to save space.

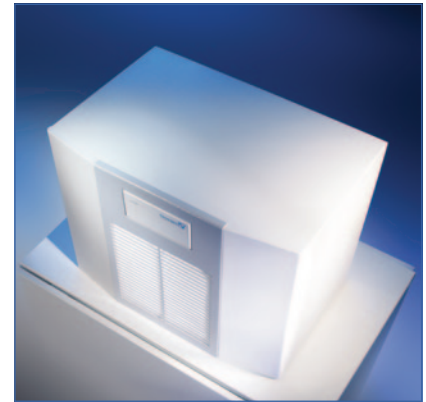

Further advantages of the DTT Series:

- **Excellent security level** due to patented condensate management system
- **Perfect service-friendliness** and long maintenance intervals
- **Product variety:** 3 installation sizes with 6 performance levels available
- **Modern design** and large selection of surface finishes and colors
- **Environmental protection** thanks to energy efficiency and recyclability
- **Easy mounting:** quick release mounting frame

The proven industry standard: DTI/DTS Cooling Units for partially-recessed and side mounted installation

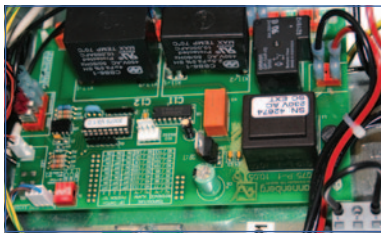

Innovative Technology

- Condenser with 3 mm fin spacing, highly effective protection against strongly contaminated ambient air
- Large distance between intake and exhaust vents, safe circulation within the electrical enclosure due to long passage of air, therefore hot spots are eliminated
- Standard controller allows for quick set up and error reporting to customer

Ease of Service and Mounting

- Integrated Cooling System[®]: DTI 9x41, mounted by 1 man in 2 minutes
- Easy access to fans and electronics for quick changes in the field

High Variability

- Integrated condensate evaporation system
- Coated condensers and pipes standard for all outdoor and washdown NEMA units
- High pressure switches to protect compressors are standard on ALL Pfannenberg Cooling Units
- Integrated Cooling System[®]: one mounting cut-out for 5 different performances

Conforms to International Standards

- Global approval such as CE, UL, cUL, some GOST for Russia and CSA for Canada
- DTS Cooling Units up to protection class NEMA 4/4X

Type	Cooling Capacity Btu/h	Rated Voltage	Dimensions H x W x D Inches (mm)	Approvals				Page
				UL	cUL	GOST	CE	
DTS Series Indoor Side Mount NEMA Type 12 Cooling Units								
DTS 1200	900 - 1200	115 V / 230 V	13 (330) x 14.76 (375) x 7.48 (190)	●	●		●	15
DTS 3021	90-1300	115 V / 230 V	15.5 (393.7) x 7 (177.8) x 7.75 (196.8)	●	●		●	17
DTS 2000	1500 - 2000	115 V / 230 V	17.52 (445) x 12.4 (315) x 10.04 (255)	●	●		●	19
DTS 3041	2000 - 3000	115 V / 230 V	20.16 x 10.08 x 10.79 (512 x 256 x 274)	●	●		●	21
DTS 3141	3000 - 4000	115 V / 230 V / 400/460 V	29.45 x 15.55 x 11.57 (748 x 395 x 294)	●	●		●	23
DTS 3141 SL	3000 - 5000	115 V / 230 V / 400/460 V	36 (914) x 12 (305) x 12 (302)	●	●		●	25
DTS 3145	5000 - 6000	115 V / 230 V / 400/460 V	36 (914) x 12 (305) x 12 (302)	●	●		●	27
DTS 3241	7000 - 8500	115 V / 230 V / 460 V	47.60 x 15.55 x 12.83 (1209 x 395 x 326)	●	●		●	29
DTS 3245	9000 - 12000	115 V / 230 V / 400/460 V	53 (1347) x 16.2 (411) x 11.9 (301)	●	●		●	31
DTS 3341	12000 - 14000	230 V / 400 V / 460 V	59.13 x 15.87 x 18.42 (1502 x 403 x 363)	●	●		●	33
DTS 3541	16000 - 18000	230 V / 400 V / 460 V	59.13 x 19.02 x 21.02 (1502 x 483 x 428)	●	●		●	35
DTS 3641	20000 - 24000	230 V / 400 V / 460 V	65.63 x 19.02 x 25.53 (1667 x 483 x 518)	●	●		●	37

Type	Cooling Capacity Btu/h	Rated Voltage	Dimensions H x W x D Inches (mm)	Approvals				Page
				UL	cUL	GOST	CE	
DTT Series Top Mount NEMA 12 Cooling Units								
DTT 6101	1200 - 2000	115 V / 230 V	17.13 x 23.43 x 15.55 (435 x 595 x 395)	●	●		●	39
DTT 6201	2500 - 4000	115 V / 230 V / 400/460 V	17.13 x 23.43 x 15.55 (435 x 595 x 395)	●	●		●	39
DTT 6301	4000 - 5500	115 V / 230 V / 460 V	17.13 x 23.43 x 19.49 (435 x 595 x 495)	●	●		●	41
DTT 6401	5500 - 7000	115 V / 230 V / 460 V	17.13 x 23.43 x 19.49 (435 x 595 x 495)	●	●		●	41
DTT 6601	7000 - 10000	460 V	19.09 x 31.30 x 22.64 (485 x 795 x 575)	●	●		●	43
DTT 6801	12000 - 14000	460 V	19.09 x 31.30 x 22.64 (485 x 795 x 575)	●	●		●	43
DTS Series Outdoor Cooling Units - NEMA Type 3R/4								
DTS 3031	900-1300	115 V / 230 V	15.5 (393.7) x 7 (177.8) x 7.75 (196.8)	●	●		●	47
DTS 3061	2000 - 3000	115 V / 230 V	20.16 x 10.08 x 10.79 (512 x 256 x 274)	●	●		●	49
DTS 3161	3000 - 4000	115 V / 230 V / 400/460 V	29.45 x 15.55 x 11.57 (748 x 395 x 294)	●	●		●	51
DTS 3161 SL	3000 - 5000	115 V / 230 V / 400/460 V	36 (914) x 12 (305) x 12 (302)	●	●		●	53
DTS 3165	5000 - 7000	115 V / 230 V / 400/460 V	36 (914) x 12 (305) x 12 (302)	●	●		●	55
DTS 3261	7000 - 8500	115 V / 230 V / 460 V	47.60 x 15.55 x 12.83 (1209 x 395 x 326)	●	●		●	57
DTS 3265	9000 - 12000	115 V / 230 V / 400/ 460 V	53 (1347) x 16.2 (411) x 11.9 (301)	●	●		●	59
DTS 3361	12000 - 14000	230 V / 400 V / 460 V	59.13 x 15.87 x 18.42 (1502 x 403 x 468)	●	●		●	61
DTS 3561	16000 - 18000	230 V / 400 V / 460 V	59.13 x 19.02 x 21.02 (1502 x 483 x 534)	●	●		●	63
DTS 3661	20000 - 24000	230 V / 400 V / 460 V	65.63 x 19.02 x 25.53 (1667 x 483 x 623)	●	●		●	65
DTS Series Washdown Cooling Units - NEMA Type 4/4X								
DTS 3031 SS	900-1300	115 V / 230 V	15.5 (393.7) x 7 (177.8) x 7.75 (196.8)	●	●		●	69
DTS 3081	2000 - 3000	115 V / 230 V	20.16 x 10.08 x 10.79 (512 x 256 x 274)	●	●		●	71
DTS 3181	3000 - 4000	115 V / 230 V / 400/460 V	29.45 x 15.55 x 11.57 (748 x 395 x 294)	●	●		●	73
DTS 3181 SL	3000 - 5000	115 V / 230 V / 400/460 V	36 (914) x 12 (305) x 12 (302)	●	●		●	75
DTS 3185	5000 - 7000	115 V / 230 V / 400/ 460 V	36 (914) x 12 (305) x 12 (302)	●	●		●	77
DTS 3281	7000 - 8500	115 V / 230 V / 460 V	47.60 x 15.55 x 12.83 (1209 x 395 x 326)	●	●		●	79
DTS 3285	9000 - 12000	115 V / 230 V / 400/ 460 V	53 (1347) x 16.2 (411) x 11.9 (301)	●	●		●	81
DTS 3381	12000 - 14000	230 V / 400 V / 460 V	59.13 x 15.87 x 18.42 (1502 x 403 x 468)	●	●		●	83
DTS 3581	16000 - 18000	230 V / 400 V / 460 V	59.13 x 19.02 x 21.02 (1502 x 483 x 534)	●	●		●	85
DTS 3681	20000 - 24000	230 V / 400 V / 460 V	65.63 x 19.02 x 25.53 (1667 x 483 x 623)	●	●		●	87
DTI Series Integrated/Recessed (European)								
DTS 9011H	300 W	115 V / 230 V	11.81 x 19.49 x 5.51 (300 x 495 x 140)	●	●	○	●	91
DTI 9021	320 W	115 V / 230 V	12.95 x 15.16 x 9.92 (329 x 385 x 252)	●	●	●	●	93
DTI 9031	510 W	115 V / 230 V / 460 V	22.13 x 12.21 x 8.35/8.35/13.90 (562 x 310 x 212/212/353)	●	●	●	●	95
DTI 9241	1000 W	230 V / 400 / 460 V	60.59 x 19.09 x 7.09 (1536 x 485 x 180)	●	●	●	●	97
DTI 9341	1500 W	230 V / 400 / 460 V	60.59 x 19.09 x 7.09 (1536 x 485 x 180)	●	●	●	●	97
DTS 9441	2000 W	230 V / 400 / 460 V	60.59 x 19.09 x 9.45 (1536 x 485 x 240)	●	●	●	●	99
DTS 9541	2500 W	230 V / 400 / 460 V	60.59 x 19.09 x 9.45 (1536 x 485 x 240)	●	●	●	●	99
DTS 9841	4000 W	400 / 460 V	60.59 x 19.09 x 14.17 (1539 x 485 x 360)	●	●	●	●	101
Thermal-Electric Peltier Indoor Cooling Units								
PTM 100	100 W	24 VDC	14.45 (367) x 7.13 (181) x 8.9 (226)				●	103
PTM 150	150 W	24 VDC	19.49 (495) x 7.13 (181) x 8.9 (226)				●	103
DTS Series Water Cooled Cooling Units								
DTS 31X5 WC	6000-8000	VDC		●	●		●	107
DTS 32X5 WC	10000 - 12000	VDC		●	●		●	107
DTS Series High Temperature Cooling Units								
DTS 3265 HT	2800 W	230 V ONLY	53 (1347) x 16.2 (411) x 11.9 (301)	●	●		●	109
DTS 3165 HT	1600 W	230 V ONLY	36 (914) x 12 (305) x 12 (302)	●	●		●	109
DTS 3061 HT	600W	230 V ONLY	20.16 x 10.08 x 10.79 (512 x 256 x 274)	●	●		●	109

● available
○ pending

Indoor NEMA Type 12 Side Mount Cooling Units

Features/Benefits:

Pfannenberg strives to provide a relatively maintenance-free design for our customers. All our designs have additional options including:

Filter Kits Option- for special applications like wood and machine tool that need an external filter to prevent clogging of the condenser core.

Corrosion Resistant Option - for special applications which require a coated condenser and copper piping, such as PVC pipe manufacturing or other indoor corrosive applications.

Voltage Options - Many of our cooling units have been designed for both 50/60 Hz applications as well as 400 or 460 V operations with a simple jumper change in the e-box.

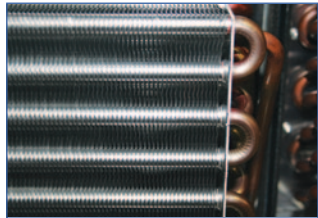

Wide Condenser Fin Spacing

This filter-free design also reduces the amount of maintenance required by the customer. A quick cleaning of the condenser is required less frequently versus the competition's models, while capacity is not compromised by easy clogging of the condenser core.



Rugged, Long-lasting Backward Curved Impeller Fans

Utilizing this type of fan, our cooling units can go twice as long before needing service versus a typical blower style fan that has smaller, low-cost and high maintenance bearings.

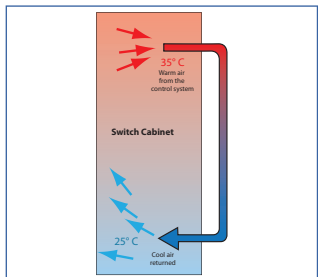

Proper Long Internal Air Flow Paths

The backward curve fan also has a natural right angle air path that allows our cooling units to capture hot air from the top of the electrical cabinet and deposit cool, dry air to the bottom of the cabinet and underneath critical components on the panel.



Hermetically Sealed Refrigeration Circuit

Utilizing a maintenance free design, Pfannenberg implements a hermetically sealed design that **eliminates gasketed valves** and the leak source for many other A/C unit designs. Therefore, our cooling units do not need annual maintenance to determine if the unit is properly charged with R134a refrigerant.



Standard Control Board

Controlling temperature and alarm setting via dip-switches, preventing airflow short cycling, high pressure switch alarm, on/off control of compressor with built-in delay timer and a LED lamp with four different flashing sequences. The control board is located in inner air circuit for protection from heat and dirt.



Application Examples

The following are just a few examples of the industries and applications in which Pfannenberg's Top Mount and Indoor Cooling Units can be utilized. Call us today to find out how you can cut costs by keeping your processes, whatever they may be, up and running with reliability you can count on.



Conveyors / Material Handling



Textile / Paper / Glass Machinery



Automation / Assembly

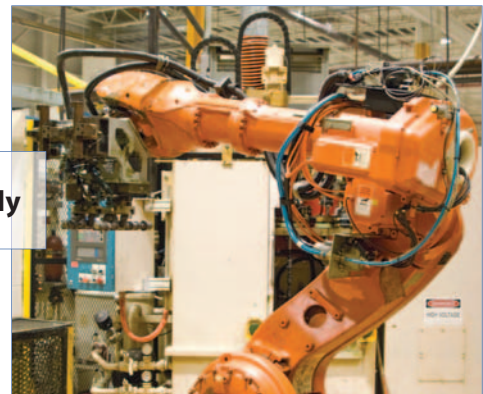

DTS 1200

Cooling Unit 900 - 1200 Btu/h



- Maintains a NEMA 12 seal against enclosure
- Recognized to UL 484, category ACVS2/8, UL File #SA10300
- CE approved for European use
- Compact side mount design for small enclosures or hot spot cooling for larger enclosures
- Powder coated steel cover for rugged environments, easily painted to match enclosure
- Uses a mechanical thermostat control

Data		DTS 1200		Unit
Part number	ANSI 61 (Gray)	13340114200	13340110200	
	RAL 7035 (Lt. Gray)	13340114055	13340110055	
Rated voltage ± 10 %		115	230	VAC
Frequency		60	50 / 60	Hz
Cooling performance according to EN 14511		900 - 1200		Btu/h
Power consumption		200		W
Nominal (Run) Current		2.2	1.3	A
Starting current		15.7	9.5	
Flow volume (actual)	Condenser	230 (391)		CFM (m³/h)
	Evaporator	106 (180)		
Fuse (Recommended)		10		A
Type of connection		6.6' Cord with Plug	6.6' Cord	
Noise level (according to EN ISO 3741)		<62		dB(A)
Weight (without packaging)		40 (18)		lb (kg)
Ambient temperature range		+ 59 ... + 131 / + 15 ... + 55		°F / °C
Control range (adjustable)		+ 77 ... + 113 / + 25 ... + 45 factory setting + 95 / + 35		
Refrigerant	type	R134a		
	quantity	280		g
Duty cycle		100 %		
Condensate management		Drain Line Included		
Protection system according to EN 60529		NEMA 12 against enclosure when properly installed		
		NEMA 1 towards the surroundings when properly installed		
Design		galvanized sheet steel		

Accessories	Piece	Part number	Information on page
Filter	1	18611600006	94
Condensate bottle	1	18314000100	94

Approvals see page 11/12

Cooling Capacity Performance Curve

DTS 1200

How to use chart
 Example:
 @ 95° F (ambient, X-axis), @ 95° F (internal, diagonal lines)
 = 825 Btu/h cooling capacity (Y-axis)

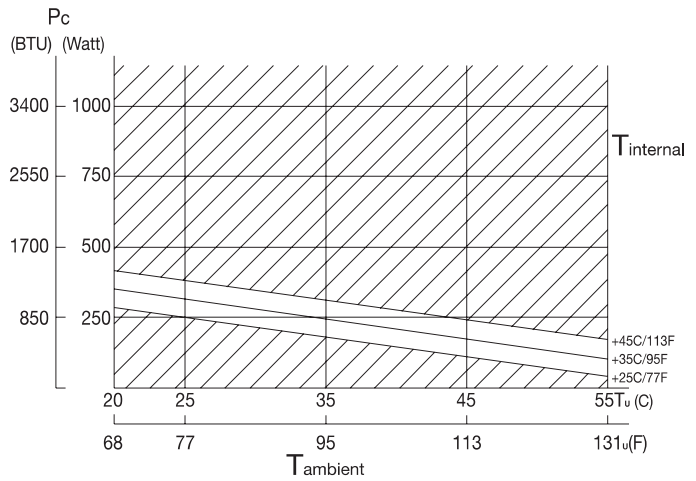

Dimensions

DTS 1200

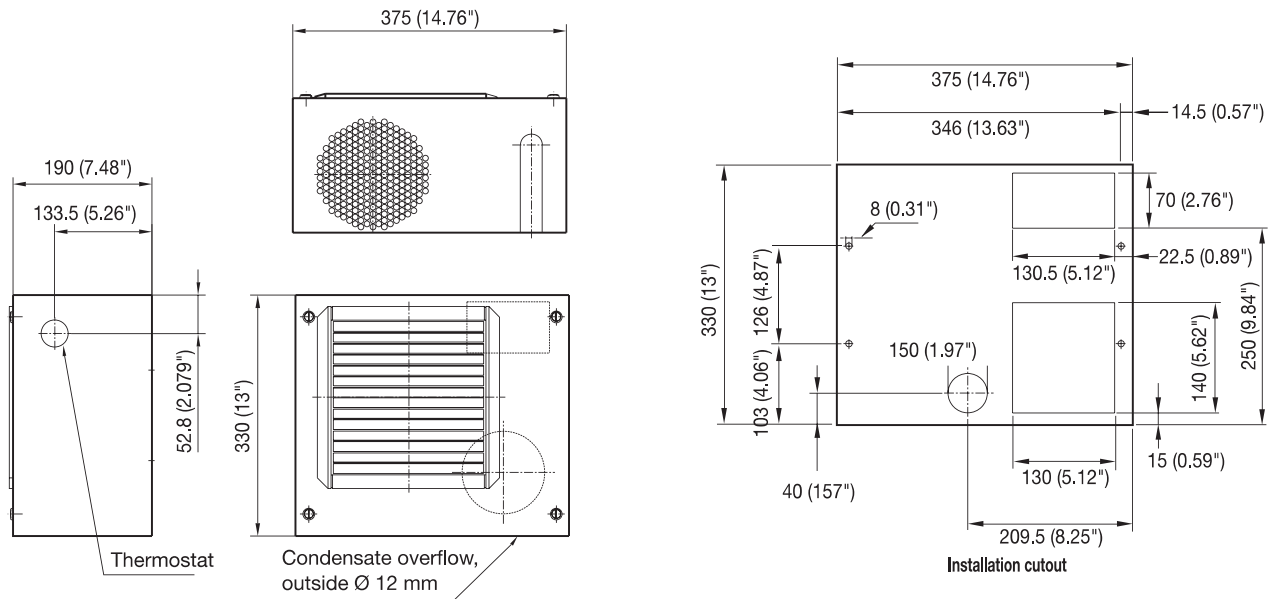

DTS 3021 (NEMA Type 12)

Cooling Unit 900 - 1300 Btu/h

- Compact design, ideal for small control cabinets or for cooling of hot spots in larger control cabinets
- Maintains a UL Tested NEMA Type 12 seal against enclosure
- UL 484 Listed, category ACVS, UL file #SA10300, CE approved for European use
- Logic connector for door contact input
- Powder coated steel cover for rugged environments, easily painted to match enclosure or machine
- Condenser with 3 mm fin spacing, highly effective protection against strongly contaminated and aggressive ambient air
- Utilizes a thermal expansion valve (TXV) to ensure maximum performance over a broad range



Data		DTS 3021 (NEMA Type 12)		Unit
Part number	ANSI 61 (Gray)	13383141251	13383144251	
	RAL 7035 (Light Gray)	13383141255	13383144255	
Rated voltage ± 10 %		230	115	VAC
Frequency		50/60	60	Hz
Cooling performance according to EN 14511		1200		Btu/h
Power consumption		315	325	W
Nominal (Run) Current @ 35/35 °C		2	3	A
Starting current		5	10	
Unimpeded airflow (free flow)	internal	38 (65)		CFM (m³/h)
	external	30 (50)		
Fuse (Recommended) Class CC		3	3	A
Type of connection		cord with molded plug		
Noise level (according to EN ISO 3741)		< 64		dB(A)
Weight (without packaging)		30 (13.6)		lb (kg)
Ambient temperature range		+ 59 ... + 131 / + 15 ... + 55		°F / °C
Control range (adjustable)		+ 77 ... + 113 / + 25 ... + 45 factory setting + 95 / + 35		
Refrigerant	type	R134a		
	quantity	150		g
Duty cycle		100 %		
Condensate management		Integrated Condensate Management System with Condensate Drain		
Protection system according to NEMA type		NEMA 12 against enclosure when properly installed		
		NEMA 1 towards the surroundings when properly installed		
Design	housing	galvanized sheet steel		
	cover	galvanized/electrostatically powder coated (200 °C)		

Options	Piece	Part number	Information on page
900W Enclosure Heater	1	Consult Factory	-
Accessories			
Metal Mesh Filter	1	805059007	94
Condensate bottle	1	18314000100	94

Approvals see page 11/12

Cooling Capacity Performance Curve

DTS 3021

How to use chart
 Example:
 @ 95° F (ambient, X-axis), @ 95° F (internal, diagonal lines)
 = 1187 Btu/h cooling capacity (Y-axis)

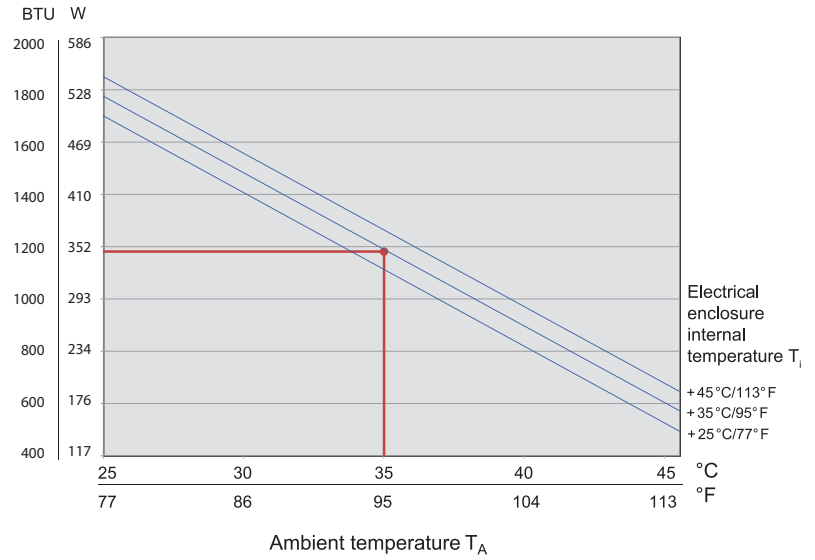

Dimensions

DTS 3021

Dimension	inches	mm
X	7	177.8
Y	15.5	393.7
Z	7.75	196.8
A	5.31	135
B	4.88	124
C	12.91	328
D	5.04	128
E	5.75	146
F	6.38	162
G	6.38	162

Mounting holes Ø 10 mm

For exact cutout information reference drilling template at pfannenbergusa.com

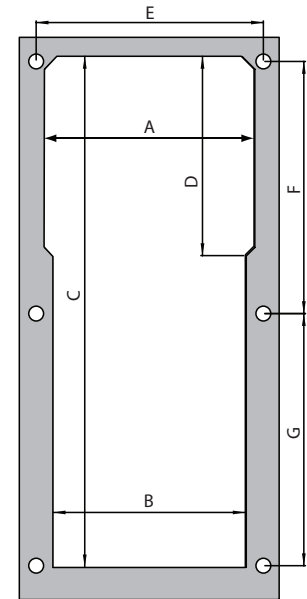
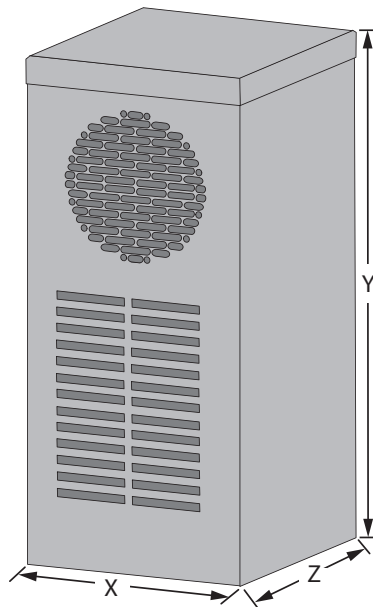

DTS 2000

Cooling Unit 1700 - 2000 Btu/h



- Maintains a NEMA 12 seal against enclosure
- Recognized to UL 484, category ACVS2/8, UL File #SA10300
- CE approved for European use
- Compact side mount design for small enclosures or hot spot cooling for larger enclosures
- Powder coated steel cover for rugged environments, easily painted to match enclosure
- Uses a mechanical thermostat control
- Condensate evaporator tray built-in

Data		DTS 2000		Unit
Part number	ANSI 61 (Gray)	13340214200	13340210200	
	RAL 7035 (Lt. Gray)	13340214055	13340210055	
Rated voltage ± 10 %		115	230	VAC
Frequency		60	50 / 60	Hz
Cooling performance according to EN 14511		1700 - 2000		Btu/h
Power consumption		270	230	W
Nominal (Run) Current		2.9	1.3	A
Starting current		13.8	9.5	
Flow volume (actual)	Condenser	230 (391)		CFM (m ³ /h)
	Evaporator	230 (391)		
Fuse (Recommended)		10		A
Type of connection		6.6' Cord with Plug	6.6' Cord	
Noise level (according to EN ISO 3741)		<62		dB(A)
Weight (without packaging)		51 (23)		lb (kg)
Ambient temperature range		+ 59 ... + 131 / + 15 ... + 55		°F / °C
Control range (adjustable)		+ 77 ... + 113 / + 25 ... + 45 factory setting + 95 / + 35		
Refrigerant	type	R134a		
	quantity	300		g
Duty cycle		100 %		
Condensate management		Drain Line Included		
Protection system according to EN 60529		NEMA 12 against enclosure when properly installed		
		NEMA 1 towards the surroundings when properly installed		
Design		galvanized sheet steel		

Accessories	Piece	Part number	Information on page
Filter	1	18611600006	94
Condensate bottle	1	18314000100	94

Approvals see page 11/12

Cooling Capacity Performance Curve

DTS 2000

How to use chart
Example:
@ 95° F (ambient, X-axis), @ 95° F (internal, diagonal lines)
= 1850 Btu/h cooling capacity (Y-axis)

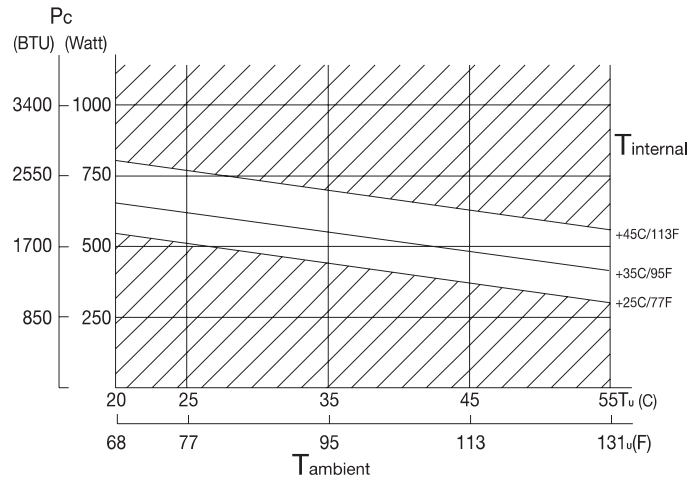

Dimensions

DTS 2000

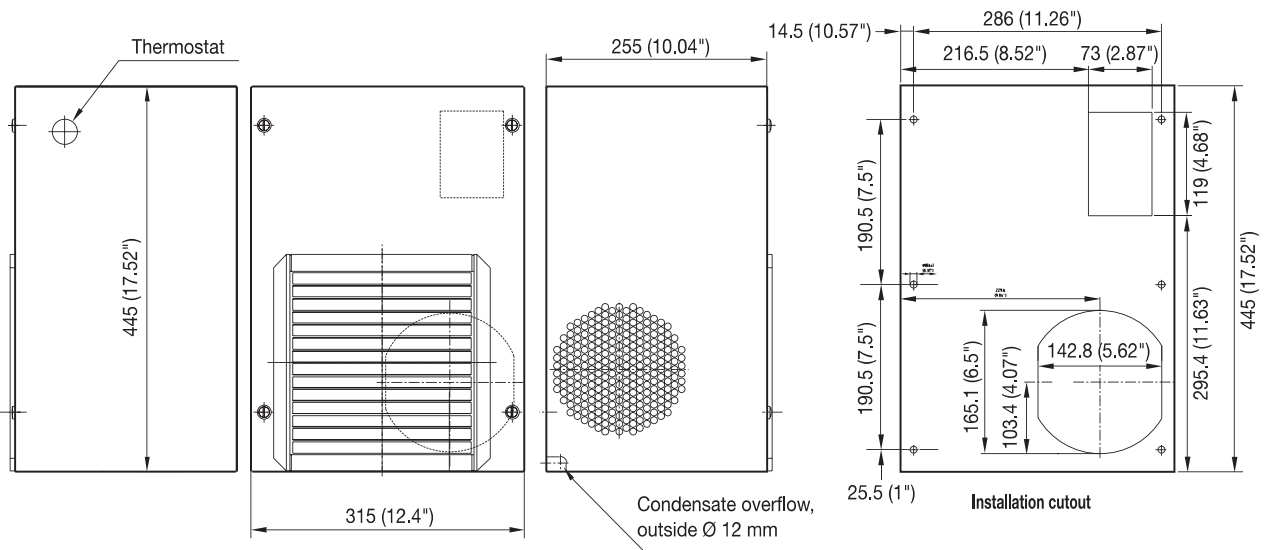

DTS 3041 (NEMA Type 12)

Cooling unit 2000 - 3000 Btu/h



- Compact design, ideal for small control cabinets or for the cooling of hot spots in larger control cabinets
- Maintains a UL Tested NEMA Type 12 seal against enclosure
- UL 484 Listed, category ACVS, UL file #SA10300, CE approved for European use
- Logic connector for door contact input and active alarm
- Powder coated steel cover for rugged environments, easily painted to match enclosure or machine
- Condenser with 3 mm fin spacing, highly effective protection against strongly contaminated and aggressive ambient air
- Utilizes a thermal expansion valve (TXV) to ensure maximum performance over a broad range

Data		DTS 3041 (NEMA Type 12)		Unit
Part number	ANSI 61 (Gray)	13382341251	13382344251	
	RAL 7035 (Light Gray)	13382341255	13382344255	
Rated voltage ± 10 %		230	115	VAC
Frequency		50/60	60*	Hz
Cooling performance according to EN 14511		2000 - 3000		Btu/h
Power consumption		663	690	W
Nominal (Run) Current @ 35/35 °C		4.1	6.0	A
Starting current		10.4	28	
Unimpeded airflow (free flow)	internal	191 (325)		CFM (m³/h)
	external	342 (582)		
Fuse (Recommended) Class CC		5	10	A
Type of connection		cord with molded plug		
Noise level (according to EN ISO 3741)		< 64		dB(A)
Weight (without packaging)		51 (23)		lb (kg)
Ambient temperature range		+ 59 ... + 131 / + 15 ... + 55		°F / °C
Control range (adjustable)		+ 77 ... + 113 / + 25 ... + 45 factory setting + 95 / + 35		
Refrigerant	type	R134a		
	quantity	400		g
Duty cycle		100 %		
Condensate management		Integrated Condensate Management System with Condensate Drain		
Protection system according to NEMA type		NEMA 12 against enclosure when properly installed		
		NEMA 1 towards the surroundings when properly installed		
Design	housing	galvanized sheet steel		
	cover	galvanized/electrostatically powder coated (200 °C)		

*50 Hz unit available. Consult factory.

Accessories	Piece	Part number	Information on page
Metal Mesh Filter	1	815065000	94
Condensate bottle	1	18314000100	94

Approvals see page 11/12

Cooling Capacity Performance Curve

DTS 3041

How to use chart

Example:
@ 95° F (ambient, X-axis), @ 95° F
(internal, diagonal lines)
= 2660 Btu/h cooling capacity (Y-axis)

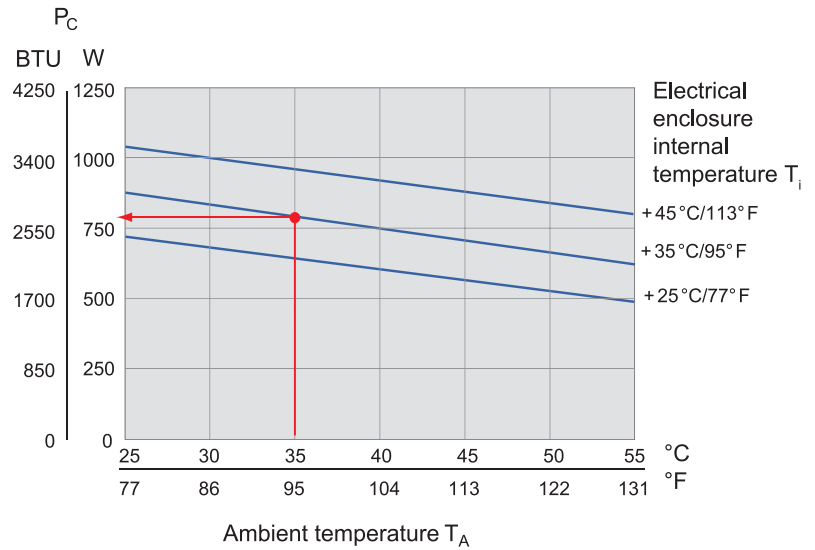

Dimensions

DTS 3041

Dimension	inches (mm)
X	10.9 (256)
Y	20.2 (512)
Z	10.8 (274)
A	6.0 (152)
B	9.1 (230)
C	8.3 (210)
D	1.0 (26)
E	8.0 (203)
F	8.9 (226)
G	9.4 (238)
H	.06 (14)
I	3.0 (76)

Mounting holes \varnothing 7.9 mm

For exact cutout information reference drilling template at pfannenbergusa.com

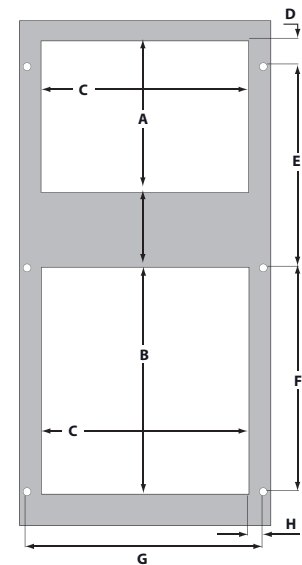
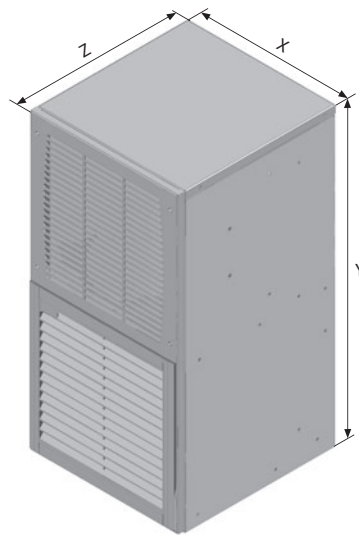

DTS 3141 (NEMA Type 12)

Cooling unit 3000 - 4000 Btu/h



- Long internal air path captures heat above components and provides cool air below
- Maintains a UL Tested NEMA Type 12 seal against enclosure
- UL 484 Listed, category ACVS, UL file #SA10300, CE approved for European use
- Standard Controller (SC) with active alarm and door contact input
- Powder coated steel cover for rugged environments, easily painted to match enclosure or machine
- Condenser with 3 mm fin spacing, highly effective protection against strongly contaminated and aggressive ambient air
- Utilizes a thermal expansion valve (TXV) to ensure maximum performance over a broad range

Data		DTS 3141 (NEMA Type 12)			Unit
Part number	ANSI 61 (Gray)	13385436251	13385441251	13385444251	
	RAL 7035 (Light Gray)	13385436255	13385441255	13385444255	
Rated voltage ± 10 %		400/460 1Ø	230	115	VAC
Frequency		50 / 60		60	Hz
Cooling performance according to EN 14511		3000 - 4000			Btu/h
Power consumption		760	712	712	W
Nominal (Run) Current @ 35A/35A °C		2	4.2	7.2	A
Starting current		8	17	28	
Unimpeded airflow (free flow)	internal	350 (206)			CFM (m³/h)
	external	350 (206)			
Fuse (Recommended)** Class CC		3	6	10	A
Type of connection		permanent spring terminal			
Noise level (according to EN ISO 3741)		< 70			dB(A)
Weight (without packaging)		95 (43)			lb (kg)
Ambient temperature range		+ 59 ... + 131 / + 15 ... + 55			°F / °C
Control range (adjustable)		SC	+ 77 ... + 113 / + 25 ... + 45; factory setting + 95 / + 35		
Refrigerant	type	R134a			
	quantity	400			g
Duty cycle		100 %			
Condensate management		active condensate evaporation system with safety overflow			
Protection system according to NEMA type		NEMA 12 against enclosure when properly installed			
		NEMA 1 towards the surroundings when properly installed			
Design	housing	galvanized sheet steel			
	cover	galvanized/electrostatically powder coated (200 °C); stainless steel on request			

** SCCR rating - See user manual for instructions to achieve 50 kA (460 v).

Accessories	Piece	Part number	Information on page
Metal Mesh Filter	1	18881500000	94
Condensate bottle	1	18314000100	94

Approvals see page 11/12

Cooling Capacity Performance Curve

DTS 3141

How to use chart

Example:
@ 95° F (ambient, X-axis), @ 95° F (internal, diagonal lines)
= 3755 Btu/h cooling capacity (Y-axis)

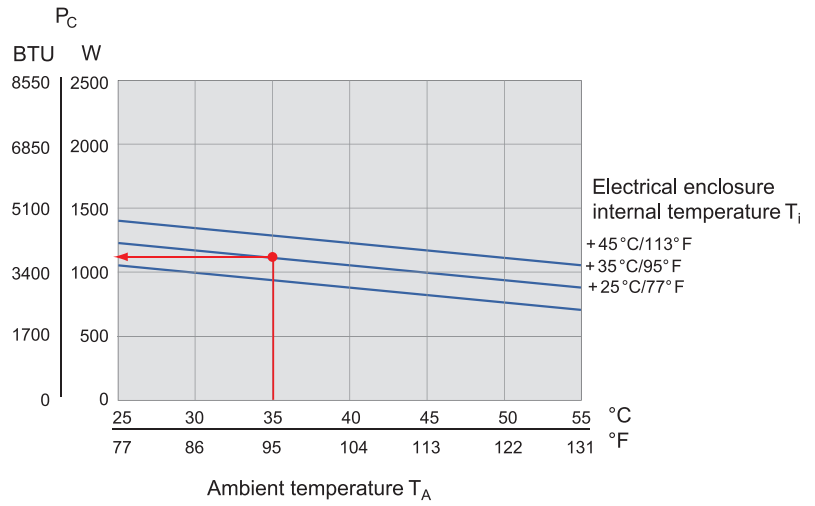

Dimensions

DTS 3141

Dimension	inches (mm)
X	15.6 (395)
Y	29.3 (748)
Z	9.3 (237)
A	11.8 (300)
B	12.2 (310)
C	2.2 (56)
D	11.5 (292)
E	1.0 (25)
F	9.0 (229)
G	1.5 (38)
H	3.2 (81)
I	14.2 (360)
J	10.1 (257)
K	1.3 (34)
L	7.9 (200)
M	3.2 (80)

Mounting holes \varnothing 8 mm

For exact cutout information reference drilling template at pfannenbergusa.com

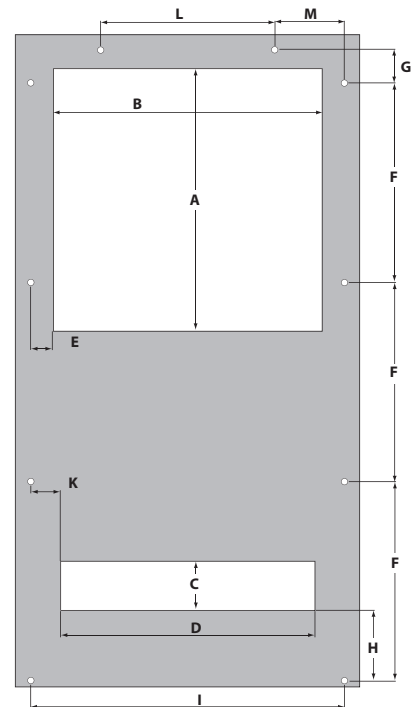
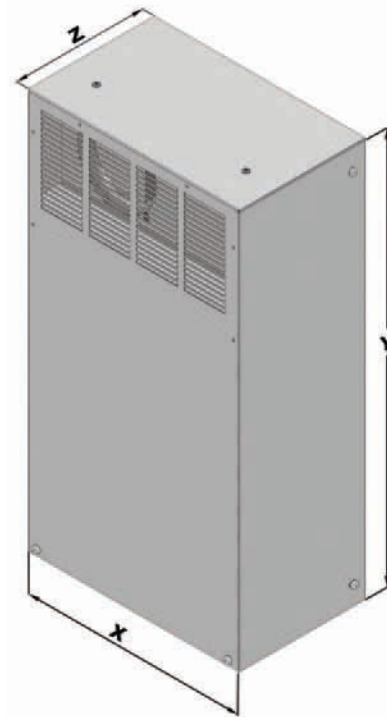

DTS 3141 SL (NEMA Type 12)

Cooling Unit 3000 - 5000 Btu/h

- Long internal air path captures heat above components and provides cool air below
- Maintains a UL Tested NEMA Type 12 seal against enclosure
- UL 484 Listed, category ACVS, UL file #SA10300, CE approved for European use
- Standard Controller (SC) with active alarm and door contact input
- Powder coated steel cover for rugged environments, easily painted to match enclosure or machine
- Condenser with 3 mm fin spacing, highly effective protection against strongly contaminated and aggressive ambient air
- 12" Width fits standard 12" NEMA enclosure depth
- Utilizes a thermal expansion valve (TXV) to ensure maximum performance over a broad range



Data		DTS 3141 SL (NEMA Type 12)			Unit
Part number	ANSI 61 (Gray)	13383436251	13383441251	13383444251	
	RAL 7035 (Light Gray)	13383436255	13383441255	13383444255	
Rated voltage ± 10 %		400 / 460 1Ø	230	115	VAC
Frequency		50/60	50/60	60	Hz
Cooling performance according to EN 14511		3000 - 5000			Btu/h
Power consumption		751	890	917	W
Nominal (Run) Current @ 35A/35A °C		1.9	4	8.5	A
Starting current		14.8	14.8	28	
Unimpeded airflow (free flow)	internal	341 (580)	341 (580)	365 (620)	CFM (m³/h)
	external	706 (1200)	706 (1200)	765 (1300)	
Fuse (Recommended)** Class CC		15	15	15	A
Type of connection		permanent spring terminal			
Noise level (according to EN ISO 3741)		< 70			dB(A)
Weight (without packaging)		108 (49)			lb (kg)
Ambient temperature range		+ 59 ... + 131 / + 15 ... + 55		+ 59 ... + 113 / + 15 ... + 45	°F / °C
Control range (adjustable)		SC + 77 ... + 113 / + 25 ... + 45; factory setting + 95 / + 35			
Refrigerant	type	R134a			
	quantity	900			g
Duty cycle		100 %			
Condensate management		active condensate evaporation system with safety overflow			
Protection system according to NEMA type		NEMA 12 against enclosure when properly installed			
		NEMA 1 towards the surroundings when properly installed			
Design	housing	galvanized sheet steel			
	cover	galvanized/electrostatically powder coated (200 °C)			

** SCCR rating - See user manual for instructions to achieve 200 kA (460 V) SCCR rating.

Accessories	Piece	Part number	Information on page
Metal Mesh Filter	1	18881500006	94
Condensate bottle	1	18314000100	94

Approvals see page 11/12

Cooling Capacity Performance Curve

DTS 3141 SL

How to use chart

Example:
@ 95° F (ambient, X-axis), @ 95° F
(internal, diagonal lines)
= 5107 Btu/h cooling capacity (Y-axis)

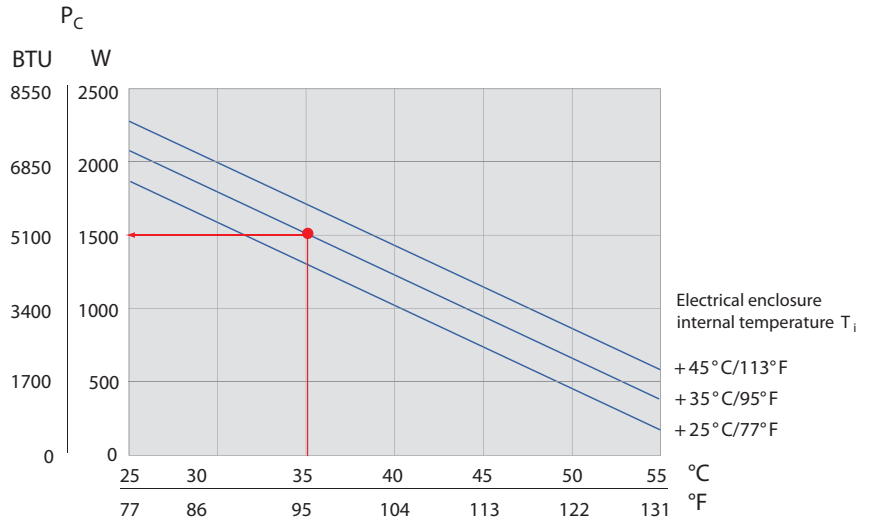

Dimensions

DTS 3141 SL

Dimension	inches (mm)
X	12 (304)
Y	36 (914)
Z	12 (304)
A	17 (430)
B	10.4 (264)
C	4.7 (118)
D	.30 (8)
E	8.5 (216)
F	8.5 (216)
G	1.3 (32)
H	.5 (13)
I	3.2 (80)
J	11 (279)
K	9 (228)

Mounting holes \varnothing 10 mm

For exact cutout information reference drilling template at pfannenbergusa.com

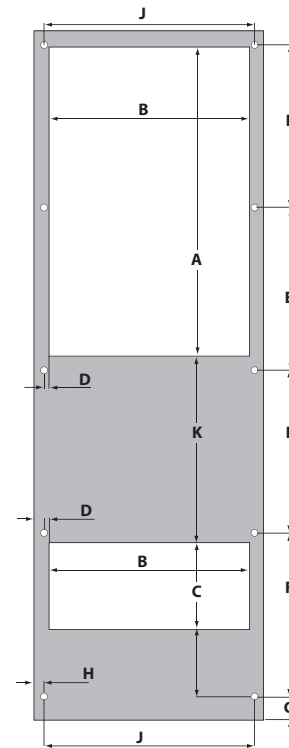
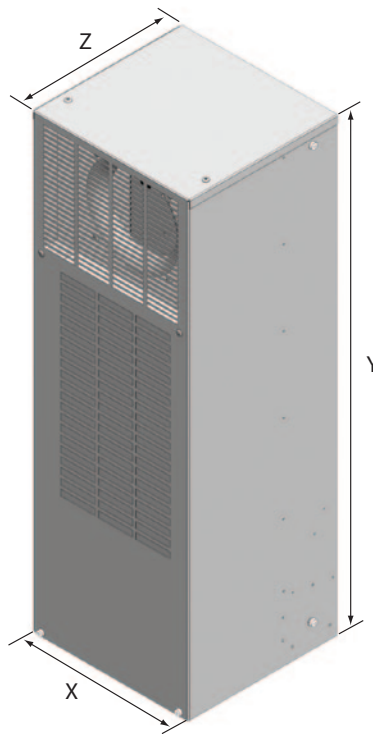

DTS 3145

Cooling Unit 5000 - 7000 Btu/h

- Long internal air path captures heat above components and provides cool air below
- Maintains a UL Tested NEMA Type 12 seal against enclosure
- UL 484 Listed, category ACVS, UL file #SA10300, CE approved for European use
- Standard Controller (SC) with active alarm and door contact input
- Powder coated steel cover for rugged environments, easily painted to match enclosure or machine
- Condenser with 3 mm fin spacing, highly effective protection against strongly contaminated and aggressive ambient air
- 12" Width fits standard 12" NEMA enclosure depth
- Utilizes a thermal expansion valve (TXV) to ensure maximum performance over a broad range



Data		DTS 3145 (NEMA Type 12)			Unit
Part number	ANSI 61 (Gray)	13383636251	13383639251	13383644251	
	RAL 7035 (Light Gray)	13383636255	13383639255	13383644255	
Rated voltage ± 10 %		400 / 460 3Ø	230	115	VAC
Frequency		50/60	50/60	60	Hz
Cooling performance according to EN 14511		5000 - 7000			Btu/h
Power consumption		1283	1020	1000	W
Nominal (Run) Current @ 35A/35A °C		2.0	4.5	8.5	A
Starting current		16	26	48	
Unimpeded airflow (free flow)	internal	341 (580)	341 (580)	365 (620)	CFM
	external	706 (1200)	706 (1200)	765 (1300)	(m³/h)
Fuse (Recommended)** Class CC		10	15	20	A
Type of connection		permanent spring terminal			
Noise level (according to EN ISO 3741)		< 70			dB(A)
Weight (without packaging)		108 (49)			lb (kg)
Ambient temperature range		+ 59 ... + 131 / + 15 ... + 55			°F / °C
Control range (adjustable)		SC	+ 77 ... + 113 / + 25 ... + 45; factory setting + 95 / + 35		
Refrigerant	type	R134a			
	quantity	900			g
Duty cycle		100 %			
Condensate management		active condensate evaporation system with safety overflow			
Protection system according to NEMA type		NEMA 12 against enclosure when properly installed			
		NEMA 1 towards the surroundings when properly installed			
Design	housing	galvanized sheet steel			
	cover	galvanized/electrostatically powder coated (200 °C)			

** SCCR rating - See user manual for instructions to achieve 200 kA (460 V) SCCR rating.

Accessories	Piece	Part number	Information on page
Metal Mesh Filter	1	18881500006	94
Condensate bottle	1	18314000100	94

Approvals see page 11/12

Cooling Capacity Performance Curve

DTS 3145

How to use chart
Example:
@ 95° F (ambient, X-axis), @ 95° F (internal, diagonal lines)
= 6140 Btu/h cooling capacity (Y-axis)

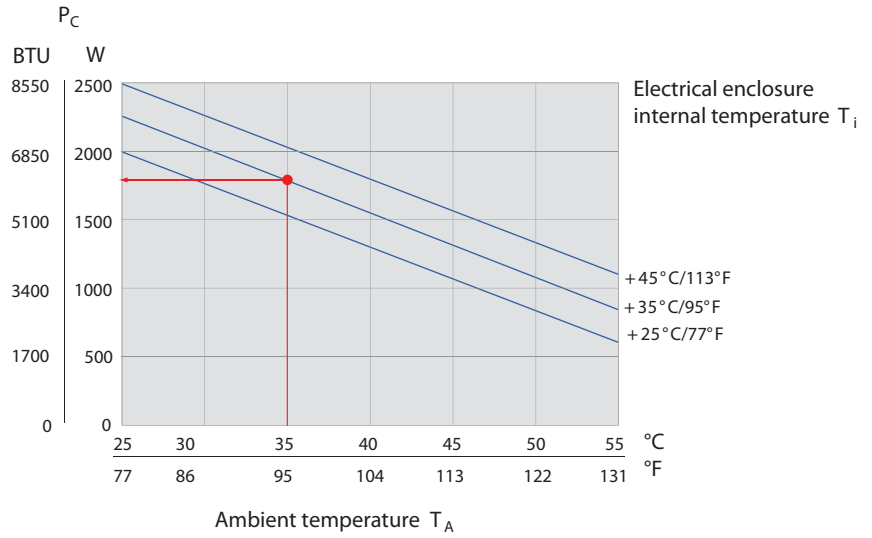

Dimensions

DTS 3145

Dimension	inches (mm)
X	12 (304)
Y	36 (914)
Z	12 (304)
A	17 (430)
B	10.4 (264)
C	4.7 (118)
D	.30 (8)
E	8.5 (216)
F	8.5 (216)
G	1.3 (32)
H	.5 (13)
I	3.2 (80)
J	11 (279)
K	9 (228)

Mounting holes \varnothing 10 mm

For exact cutout information reference drilling template at pfannenbergusa.com

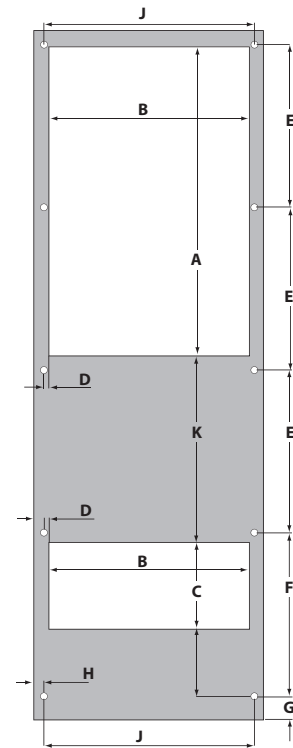
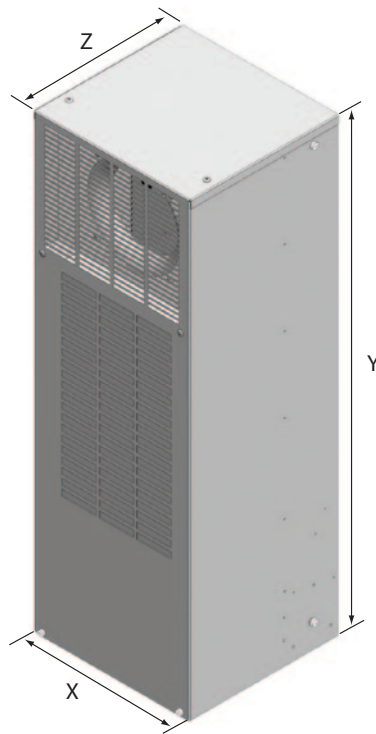

DTS 3241 (NEMA Type 12)

Cooling unit 7000 - 8500 Btu/h



- Long internal air path captures heat above components and provides cool air below
- Maintains a UL Tested NEMA Type 12 seal against enclosure
- UL 484 Listed, category ACVS, UL file #SA10300, CE approved for European use
- High protection system IP 56, maintenance-free
- Powder coated steel cover for rugged environments, easily painted to match enclosure or machine
- Condenser with 3 mm fin spacing, highly effective protection against strongly contaminated and aggressive ambient air
- Uses Internal Standard Control (SC) board
- Condensate evaporator tray built-in
- Utilizes a thermal expansion valve (TXV) to ensure maximum performance over a broad range

Data		DTS 3241 (NEMA Type 12)			Unit
Part number	ANSI 61 (Gray)	13385736251	13385741251	13385744251	
	RAL 7035 (Light Gray)	13385736255	13385741255	13385744255	
Rated voltage ± 10 %		400 / 460 3Ø	230	115	VAC
Frequency		50 / 60	50 / 60	60	Hz
Cooling performance according to EN 14511		7000 - 8500			Btu/h
Power consumption		1400	1425	1680	W
Nominal (Run) Current @ 35A/35A °C		3.0	4.3	7.2	A
Starting current		10	21.8	53	
Unimpeded airflow (free flow)	internal	580 (985)			CFM (m³/h)
	external	580 (985)			
Fuse (Recommended)** Class CC		5	10	25	A
Type of connection		permanent spring terminal			
Noise level (according to EN ISO 3741)		< 73			dB(A)
Weight (without packaging)		119 (54)			lb (kg)
Ambient temperature range		+ 59 ... + 131 / + 15 ... + 55			°F / °C
Control range (adjustable)		SC + 77 ... + 113 / + 25 ... + 45; factory setting + 95 / + 35			
Refrigerant	type	R134a			g
	quantity	700			
Duty cycle		100 %			
Condensate management		active condensate evaporation system with safety overflow			
Protection system according to NEMA type		NEMA 12 against enclosure when properly installed			
		NEMA 1 towards the surroundings when properly installed			
Design	housing	galvanized sheet steel			
	cover	galvanized/electrostatically powder coated (200 °C)			

** SCCR rating - See user manual for instructions to achieve 50 kA (230 v) or 200 kA (460 V) SCCR rating.

Accessories	Piece	Part number	Information on page
Metal Mesh Filter	1	18881500001	94
Condensate bottle	1	18314000100	94

Approvals see page 11/12

Cooling Capacity Performance Curve

DTS 3241

How to use chart

Example:
@ 95° F (ambient, X-axis), @ 95° F
(internal, diagonal lines)
= 7850 Btu/h cooling capacity (Y-axis)

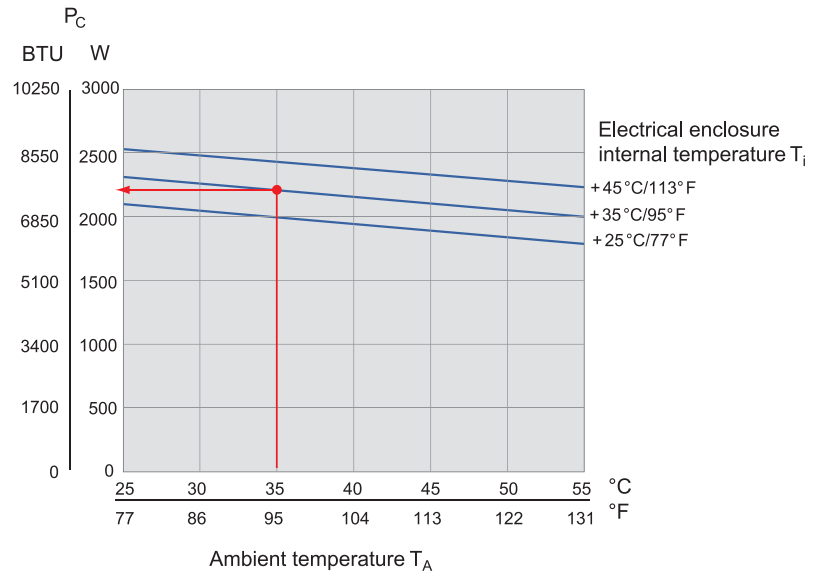

Dimensions

DTS 3241

Dimension	inches (mm)
X	15.6 (395)
Y	47.6 (1209)
Z	10.6 (269)
A	13.8 (350)
B	13.0 (330)
C	3.9 (100)
D	11.5 (292)
E	.59 (15)
F	9.0 (229)
G	1.5 (38)
H	6.4 (162)
I	14.2 (360)
J	21.5 (545)
K	1.4 (34)
L	7.9 (200)
M	3.2 (80)

Mounting holes Ø 8 mm

For exact cutout information reference drilling template at pfannenbergusa.com

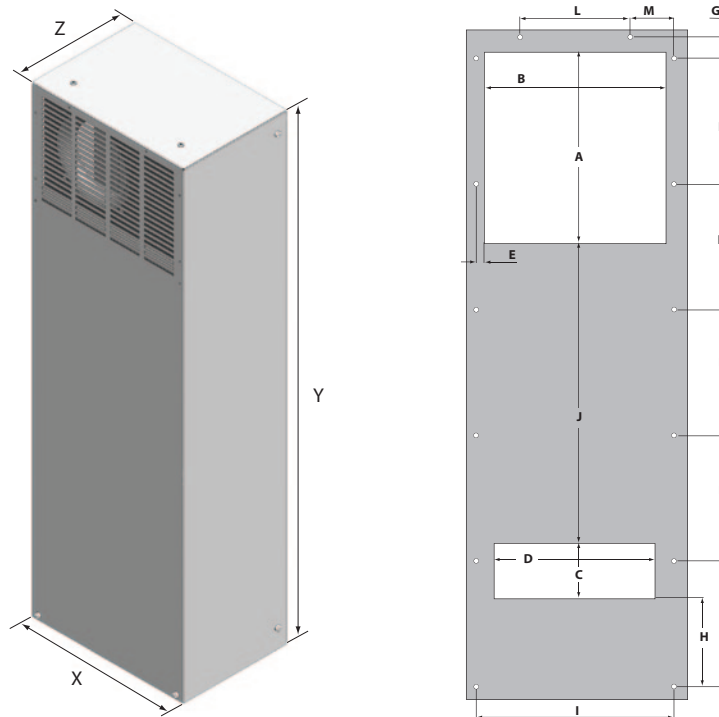

DTS 3245

Cooling Unit 9000 - 12000 Btu/h

- Long internal air path captures heat above components and provides cool air below
- Maintains a UL Tested NEMA Type 12 seal against enclosure
- UL 484 Listed, category ACVS, UL file #SA10300, CE approved for European use
- High protection system IP 56, maintenance-free
- Powder coated steel cover for rugged environments, easily painted to match enclosure or machine
- Condenser with 3 mm fin spacing, highly effective protection against strongly contaminated and aggressive ambient air
- Uses Internal Standard Control (SC) board
- Condensate evaporator tray built-in
- Utilizes a thermal expansion valve (TXV) to ensure maximum performance over a broad range



Data		DTS 3245 (NEMA Type 12)			Unit
Part number	ANSI 61 (Gray)	13383836251	13383839251	13383844251	
	RAL 7035 (Light Gray)	13383836255	13383839255	13383844255	
Rated voltage ± 10 %		400 / 460 3Ø	230	115	VAC
Frequency		50/60	50/60	60	Hz
Cooling performance according to EN 14511		9000 - 12000			Btu/h
Power consumption		1700	1600	1600	W
Nominal (Run) Current @ 35A/35A °C		2.6	6.5	13	A
Starting current		6.3	30	57	
Unimpeded airflow (free flow)	internal	706 (1200)	706 (1200)	765 (1300)	CFM
	external	706 (1200)	706 (1200)	765 (1300)	(m³/h)
Fuse (Recommended)** Class CC		10	15	30	A
Type of connection		permanent spring terminal			
Noise level (according to EN ISO 3741)		< 73			dB(A)
Weight (without packaging)		150 (68)			lb (kg)
Ambient temperature range		+ 59 ... + 131 / + 15 ... + 55			°F / °C
Control range (adjustable)		SC + 77 ... + 113 / + 25 ... + 45; factory setting + 95 / + 35			
Refrigerant	type	R134a			
	quantity	1200			g
Duty cycle		100 %			
Condensate management		active condensate evaporation system with safety overflow			
Protection system according to NEMA type		NEMA 12 against enclosure when properly installed			
		NEMA 1 towards the surroundings when properly installed			
Design	housing	galvanized sheet steel			
	cover	galvanized/electrostatically powder coated (200 °C)			

** SCCR rating - See user manual for instructions to achieve 50 kA (230 V) or 200 kA (460 V) SCCR rating.

Accessories	Piece	Part number	Information on page
Metal Mesh Filter	1	18881500007	94
Condensate bottle	1	18314000100	94

Approvals see page 11/12

Cooling Capacity Performance Curve

DTS 3245

How to use chart
 Example:
 @ 95° F (ambient, X-axis), @ 95° F (internal, diagonal lines)
 = 10875 Btu/h cooling capacity (Y-axis)

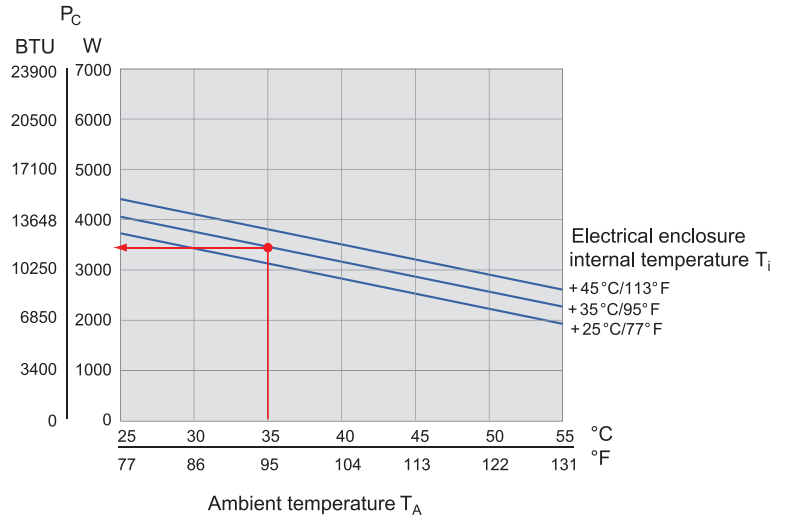

Dimensions

DTS 3245

Dimension	inches (mm)
X	16.0 (406)
Y	53.0 (1347)
Z	11.9 (301)
A	16.8 (427)
B	11 (280)
C	5.3 (135)
D	13.7 (348)
E	.98 (25)
F	.35 (9)
G	13.0 (330)
H	21.1 (537)
I	1.4 (35)
J	3.6 (92)
K	5.0 (126)
L	8.2 (209)
M	7.8 (198)
N	7.6 (192)
O	8.4 (214)
P	4.5 (114)
Q	10.5 (267)

Mounting holes \varnothing 8 mm

For exact cutout information reference drilling template at pfannenbergusa.com

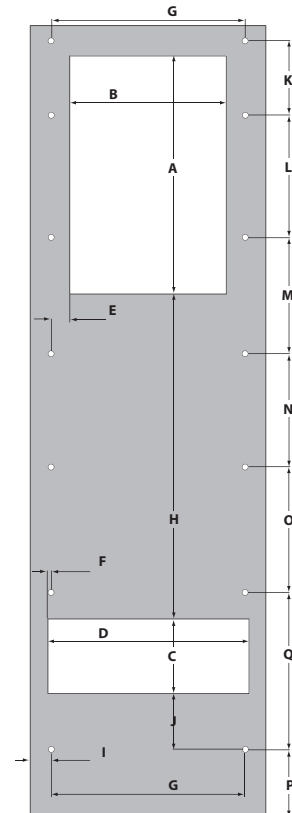

DTS 3341 (NEMA Type 12)

Cooling Unit 12000 - 14000 Btu/h



- Large distance between intake and exhaust vents, safe circulation within the electrical enclosure due to long passage of air, therefore hot spots are eliminated
- Maintains a UL Tested NEMA Type 12 seal against enclosure
- UL 484 Listed, category ACVS, UL file #SA10300, CE approved for European use
- Standard Controller (SC) with active alarm and door contact input
- Powder coated steel cover for rugged environments, easily painted to match enclosure or machine
- Condenser with 3 mm fin spacing, highly effective protection against strongly contaminated and aggressive ambient air
- Active condensate evaporation system
- Utilizes a thermal expansion valve (TXV) to ensure maximum performance over a broad range

Data		DTS 3341 (NEMA Type 12)		Unit
Part number	ANSI 61 (Gray)	13383036251	13383039251	
	RAL 7035 (Light Gray)	13383036255	13383039255	
Rated voltage ± 10 %		400/460 3Ø	230	VAC
Frequency		50 / 60	60*	Hz
Cooling performance according to EN 14511		12000 - 14000		Btu/h
Power consumption		1200 / 1600	1872	W
Nominal (Run) Current @ 35A/35A °C		3.0	8.0	A
Starting current		20	51	
Unimpeded airflow (free flow)	internal	788 (1400)		CFM (m³/h)
	external	991 (1685)		
Fuse (Recommended)** Class CC		15	20	A
Type of connection		permanent screw terminal		
Noise level (according to EN ISO 3741)		< 72		dB(A)
Weight (without packaging)		214 (97)		lb (kg)
Ambient temperature range		+ 59 ... + 131 / + 15 ... + 55		°F / °C
Control range (adjustable)	SC	+ 77 ... + 113 / + 25 ... + 45; factory setting + 95 / + 35		
Refrigerant	type	R134a		g
	quantity	1000		
Duty cycle		100 %		
Condensate management		active condensate evaporation system with safety overflow		
Protection system according to NEMA type		NEMA 12 against enclosure when properly installed		
		NEMA 1 towards the surroundings when properly installed		
Design	housing	galvanized sheet steel		
	cover	galvanized/electrostatically powder coated (200 °C)		

*50 Hz unit available. Consult factory.

** SCCR rating - See user manual for instructions to achieve 50 kA (230 V) or 200 kA (460 V) SCCR rating.

Accessories	Piece	Part number	Information on page
Metal Mesh Filter	1	18881500002	94
Condensate bottle	1	18314000100	94

Approvals see page 11/12

Cooling Capacity Performance Curve

DTS 3341

How to use chart

Example:
@ 95° F (ambient, X-axis), @ 95° F (internal, diagonal lines)
= 11250 Btu/h cooling capacity (Y-axis)

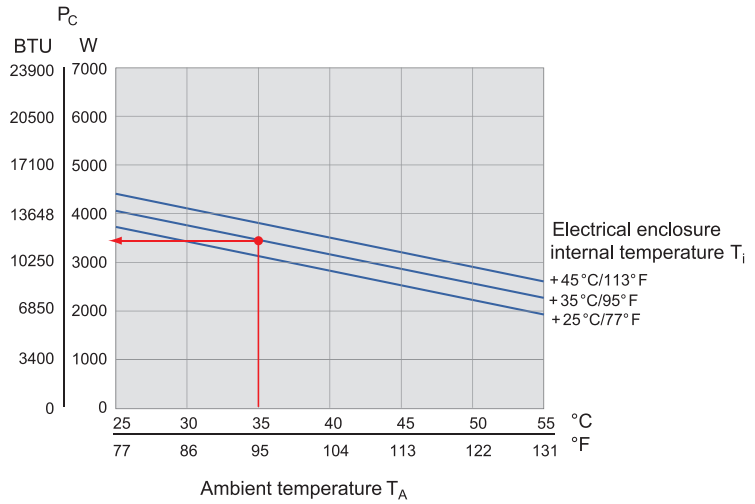

Dimensions

DTS 3341

Dimension	inches (mm)
X	15.9 (403)
Y	59.1 (1502)
Z	14.29 (363)
A	23.2 (590)
B	11.2 (285)
C	6.3 (160)
D	12.2 (310)
E	12.8 (325)
F	8.5 (216)
G	11.0 (280)
H	1.0 (26)
I	13.8 (350)
J	6.9 (175)
K	11.0 (280)
L	13.4 (340)
M	.79 (20)

Mounting holes \varnothing 8 mm

For exact cutout information reference drilling template at pfannenbergusa.com

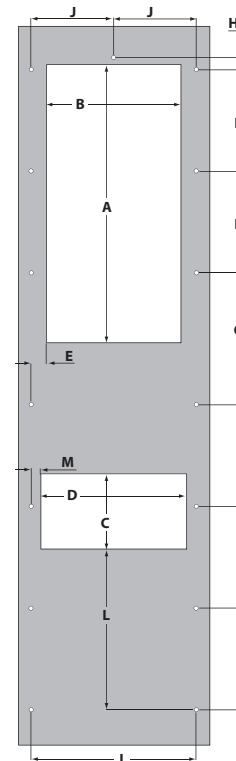
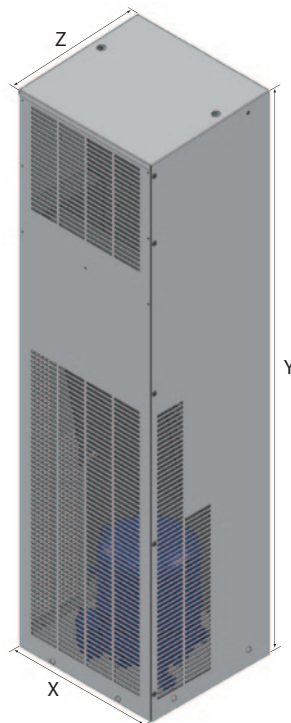

DTS 3541 (NEMA Type 12)

Cooling Unit 16000 - 18000 Btu/h



- Large distance between intake and exhaust vents, safe circulation within the electrical enclosure due to long passage of air, therefore hot spots are eliminated
- Maintains a UL Tested NEMA Type 12 seal against enclosure
- UL 484 Listed, category ACVS, UL file #SA10300, CE approved for European use
- Standard Controller (SC) with active alarm and door contact input
- Powder coated steel cover for rugged environments, easily painted to match enclosure or machine
- Condenser with 3 mm fin spacing, highly effective protection against strongly contaminated and aggressive ambient air
- Active condensate evaporation system
- Utilizes a thermal expansion valve (TXV) to ensure maximum performance over a broad range

Data		DTS 3541 (NEMA Type 12)		Unit
Part number	ANSI 61 (Gray)	13383536251	13383539251	
	RAL 7035 (Light Gray)	13383536255	13383539255	
Rated voltage ± 10 %		400 / 460 3Ø	230	VAC
Frequency		50 / 60	60*	Hz
Cooling performance according to EN 14511		16000 - 18000		Btu/h
Power consumption		1365 / 1815	2240	W
Nominal (Run) Current @ 35A/35A °C		4.4	9.2	A
Starting current		16	49.3	
Unimpeded airflow (free flow)	internal	788 (1340)		CFM
	external	1480 (2380)		(m³/h)
Fuse (Recommended) Class CC		15	30	A
Type of connection		permanent screw terminal		
Noise level (according to EN ISO 3741)		< 72		dB(A)
Weight (without packaging)		221 (100)		lb (kg)
Ambient temperature range		+ 59 ... + 131 / + 15 ... + 55		°F / °C
Control range (adjustable)		SC + 77 ... + 113 / + 25 ... + 45; factory setting + 95 / + 35		
Refrigerant	type	R134a		
	quantity	1200		g
Duty cycle		100 %		
Condensate management		active condensate evaporation system with safety overflow		
Protection system according to NEMA type		NEMA 12 against enclosure when properly installed		
		NEMA 1 towards the surroundings when properly installed		
Design	housing	galvanized sheet steel		
	cover	galvanized/electrostatically powder coated (200 °C)		

*50 Hz unit available. Consult factory.

** SCCR rating - See user manual for instructions to achieve 200 kA SCCR rating.

Accessories	Piece	Part number	Information on page
Metal Mesh Filter	1	18881500003	94
Condensate bottle	1	18314000100	94

Approvals see page 11/12

Cooling Capacity Performance Curve

DTS 3541

How to use chart
Example:
@ 95° F (ambient, X-axis),
@ 95° F (internal, diagonal lines)
= 15250 Btu/h cooling capacity (Y-axis)

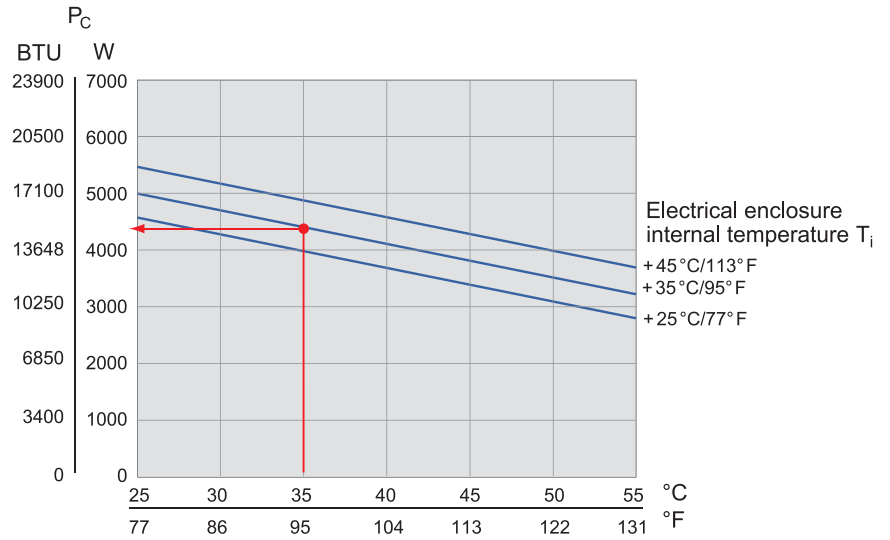

Dimensions

DTS 3541

Dimension	inches (mm)
X	19.0 (483)
Y	59.1 (1502)
Z	16.8 (428)
A	23.2 (590)
B	11.2 (285)
C	5.9 (150)
D	15.0 (380)
E	2.7 (67.5)
F	8.5 (216)
G	11.0 (280)
H	1.0 (26)
I	16.5 (420)
J	8.3 (210)
K	12.2 (310)
L	12.6 (320)
M	.79 (20)

Mounting holes \varnothing 10 mm

For exact cutout information reference drilling template at pfannenbergusa.com

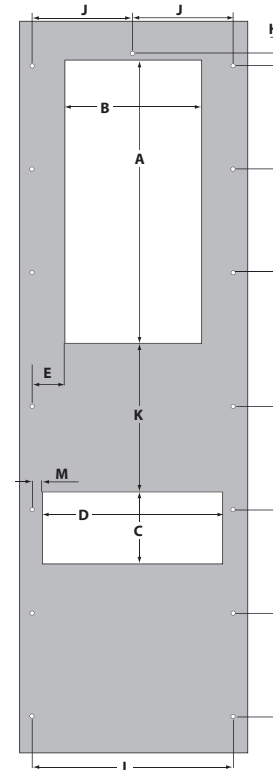
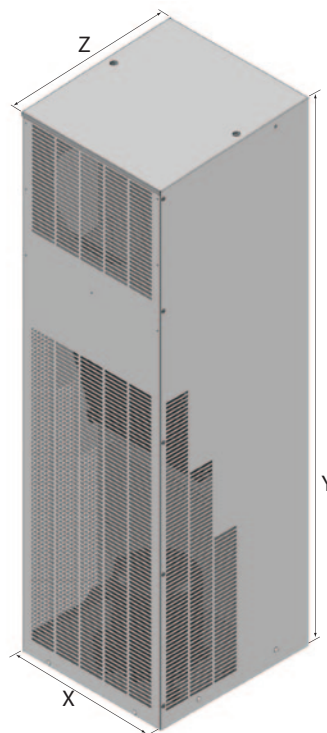

DTS 3641 (NEMA Type 12)

Cooling unit 20000 - 24000 Btu/h



- Large distance between intake and exhaust vents, safe circulation within the electrical enclosure due to long passage of air, therefore hot spots are eliminated
- Maintains a UL Tested NEMA Type 12 seal against enclosure
- UL 484 Listed, category ACVS, UL file #SA10300, CE approved for European use
- Standard Controller (SC) with active alarm and door contact input
- Powder coated steel cover for rugged environments, easily painted to match enclosure or machine
- Condenser with 3 mm fin spacing, highly effective protection against strongly contaminated and aggressive ambient air
- Active condensate evaporation system
- Utilizes a thermal expansion valve (TXV) to ensure maximum performance over a broad range

Data		DTS 3641 (NEMA Type 12)		Unit
Part number	ANSI 61 (Gray)	13383936251	13383939251	
	RAL 7035 (Light Gray)	13383936255	13383939255	
Rated voltage ± 10 %		400 / 460 3Ø	230	VAC
Frequency		50 / 60	60*	Hz
Cooling performance according to EN 14511		20000 - 24000		Btu/h
Power consumption		2000/2620	3142	
Nominal (Run) Current @ 35A/35A °C		4.8	15	A
Starting current		25	84	
Unimpeded airflow (free flow)	internal	1613 (2740)		CFM (m³/h)
	external	1613 (2740)		
Fuse (Recommended)** Class CC		15	35	A
Type of connection		permanent screw terminal		
Noise level (according to EN ISO 3741)		< 73		dB(A)
Weight (without packaging)		230 (105)		lb (kg)
Ambient temperature range		+ 59 ... + 131 / + 15 ... + 55		°F / °C
Control range (adjustable)		SC + 77 ... + 113 / + 25 ... + 45; factory setting + 95 / + 35		
Refrigerant	type	R134a		
	quantity	1300		g
Duty cycle		100 %		
Condensate management		active condensate evaporation system with safety overflow		
Protection system according to NEMA type		NEMA 12 against enclosure when properly installed		
		NEMA 1 towards the surroundings when properly installed		
Design	housing	galvanized sheet steel		
	cover	galvanized/electrostatically powder coated (200 °C)		

*50 Hz unit available. Consult factory.

** SCCR rating - See user manual for instructions to achieve 50 kA (230 V) or 200 kA (460 V) SCCR rating.

Accessories	Piece	Part number	Information on page
Metal Mesh Filter	1	18881500004	94
Condensate bottle	1	18314000100	94

Approvals see page 11/12

Cooling Capacity Performance Curve

DTS 3641

How to use chart
Example:
@ 95° F (ambient, X-axis),
@ 95° F (internal, diagonal lines)
= 20500 Btu/h cooling capacity (Y-axis)

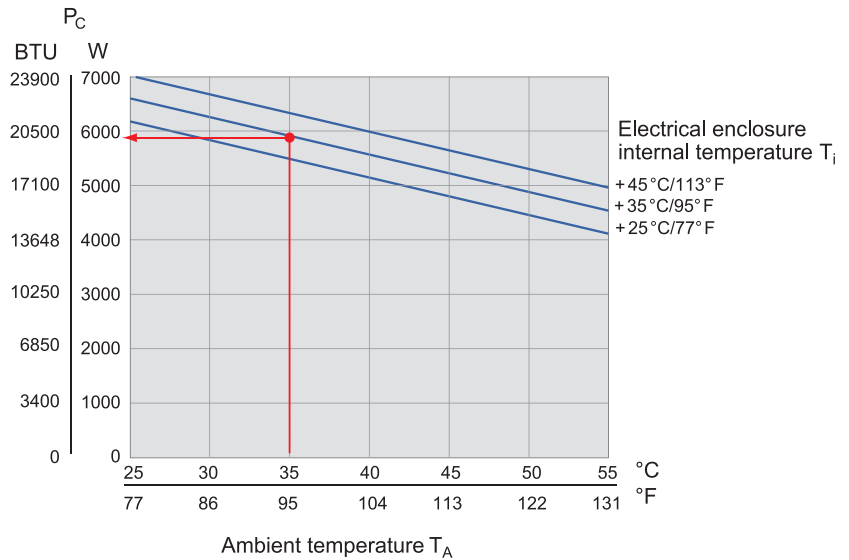

Dimensions

DTS 3641

Dimension	inches (mm)
X	19.0 (483)
Y	65.6 (1667)
Z	20.4 (518)
A	25 (635)
B	13.8 (350)
C	11.2 (285)
D	10.2 (260)
E	1.4 (35)
F	9.5 (240)
G	13.8 (350)
H	5.5 (139)
I	16.5 (420)
J	8.3 (210)
K	16.7 (425)
L	1.1 (28.5)

Mounting holes \varnothing 10 mm

For exact cutout information reference drilling template at pfannenbergusa.com

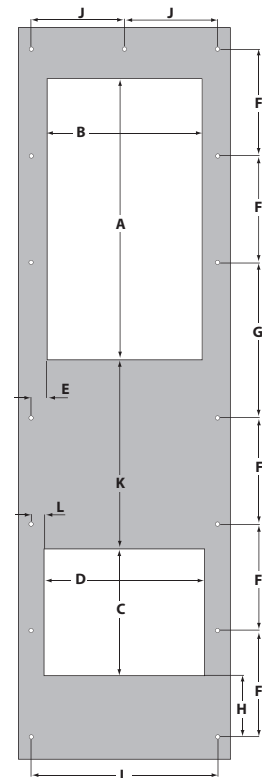
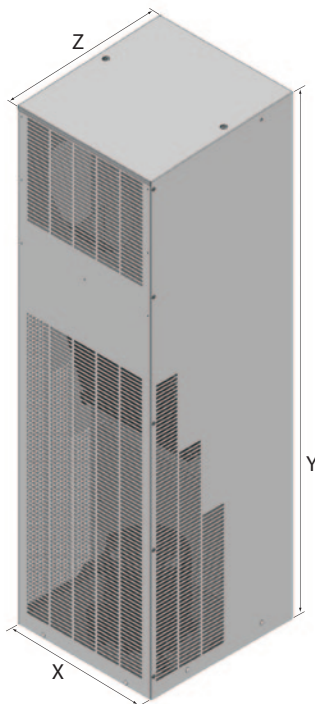

DTT 6101

Top Mounted Cooling Unit 1200 - 2000 Btu/h

DTT 6201

Top Mounted Cooling Unit 2500 - 4000 Btu/h

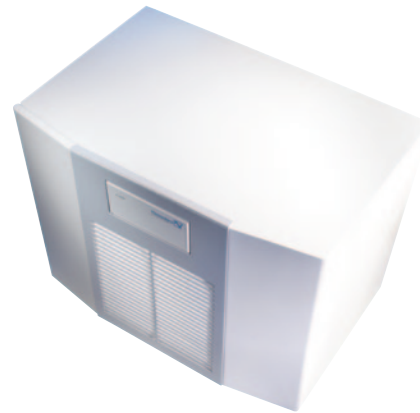

- Product variety: 3 installation sizes and 6 performances
- 4-fold protection against condensate with patented condensate management system
- Toolless mounting and maintenance due to quick-release mounting frame
- Service-friendly: complete cover removable towards the front. Easily accessible filter mats and control elements in front area.
- Energy efficiency: around 20 % saving on energy thanks to the use of more effective, lighter components
- Energy efficiency: optional multi-controller with energy-saving operation mode
- UL certification
- Design and color matching: perfect mixture of functionality and design

Data	DTT 6201			DTT 6101		Unit	
Part number	RAL 7035 (Light Gray)	13216249055	13216241055	13216244055	13216141055	13216144055	
Rated voltage ± 10 %		400 / 460 1Ø	230	115	230	115	VAC
Frequency		50 / 60					Hz
Cooling performance according to EN 14511		2500 - 4000			1200 - 2000		Btu/h
Power consumption		706 / 845	663 / 805	877	458 / 532	569	W
Nominal (Run) Current		1.5 / 1.8	3.39 / 3.83	8.05	2.2 / 2.4	5.2	A
Starting current		8.5 / 9.3	14.8 / 17.4 (60 Hz)		23.0		
Unimpeded airflow (free flow)	internal	335 / 343 (570 / 582)					CFM (m ³ /h)
	external	1071 / 1159 (1820 / 1970)					
Fuse (Recommended)		6	10	20	10	20	A
Type of connection		spring-type terminal included with plug					
Noise level (according to EN ISO 3741)		< 62					dB(A)
Weight (without packaging)		90 (41)	77 (35)		73 (33)		lb (kg)
Ambient temperature range		+ 59 ... + 131 / + 15 ... + 55					°F / °C
Control range (adjustable)	SC	+ 77 ... + 113 / + 25 ... + 45; factory setting + 95 / + 35					
Refrigerant	type	R134a					g
	quantity	400					
Duty cycle		100%					
Condensate management		active condensate evaporation system with safety overflow					
Protection system according to EN 60529		NEMA 12 against enclosure when properly installed					
		NEMA 1 towards the surroundings when properly installed					
Design	housing	galvanized sheet steel					
	cover	galvanized/electrostatically powder coated (200 °C)					

Accessories	Piece	Part number	Information on page
Fluted Filter	1	18611600037	94
Condensate bottle	1	18314000100	94

Approvals see page 11/12

Cooling Capacity Performance Curve

DTT 6201

DTT 6101

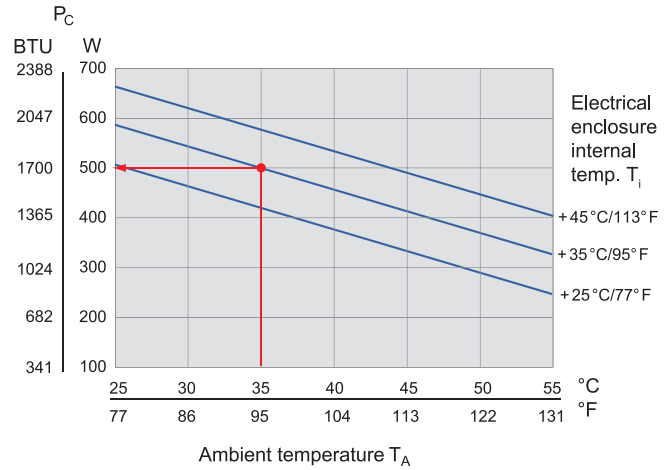
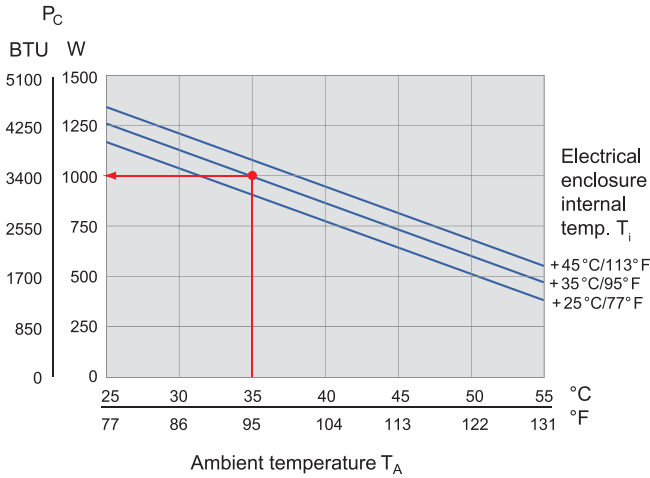

How to use chart

Example:
@ 95° F (ambient, X-axis), @ 95° F (internal, diagonal lines)
= 3400 (DTT 6201) or 1700 (DTT 6101)Btu/h cooling capacity (Y-axis)

Dimensions

DTT 6201 / DTT 6101

Dimension	inches (mm)
X	23.4 (595)
Y	17.0 (434)
Z	15.6 (395)
A	10.28 (261.2)
B	18.7 (475)

For exact cutout information reference drilling template at pfannenbergusa.com

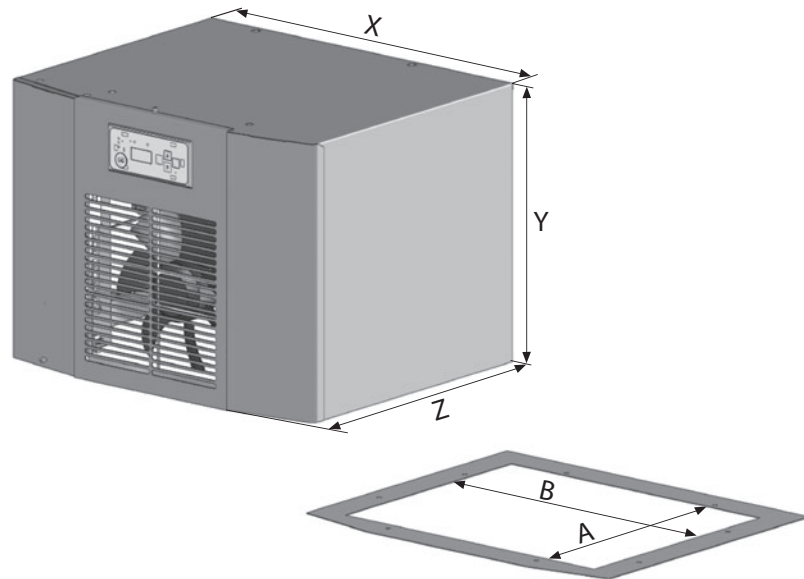

DTT 6301

Top Mounted Cooling Unit 4000 - 5500 Btu/h

DTT 6401

Top Mounted Cooling Unit 5500 - 7000 Btu/h

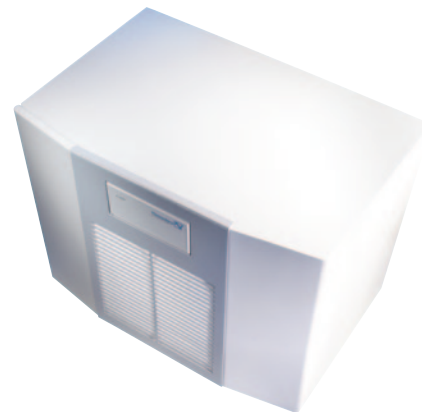

- Product variety: 3 installation sizes and 6 performances
- 4-fold protection against condensate with patented condensate management system
- Toolless mounting and maintenance due to quick-release mounting frame
- Service-friendly: complete cover removable towards the front. Easily accessible filter mats and control elements in front area.
- Energy efficiency: around 20 % saving on energy thanks to the use of more effective, lighter components
- UL certification
- Design and color matching: perfect mixture of functionality and design

Data	DTT 6401			DTT 6301			Unit	
Part number	RAL 7035 (Light Gray)	13216432055	13216441055	13216444055	13216349055	13216341055	13216344055	
Rated voltage ± 10 %		400 / 460 3Ø	230	115	400 / 460 1Ø	230	115	VAC
Frequency		50 / 60					HZ	
Cooling performance according to EN 14511		5500 - 7000			4000 - 5500			Btu/h
Power consumption		1300 / 1598	1049 / 1275	1894	962 / 1150	980 / 1140	1027	W
Nominal (Run) Current		2.3 / 2.4	5.1 / 5.5	16.5	3.1 / 3.2	6.3 / 6.4	10.8	A
Starting current		10 / 12	16.8	34	9.8	19.7	32	
Unimpeded airflow (free flow)	internal	521 / 583 (885 / 990)					CFM (m³/h)	
	external	1071 / 1159 (1820 / 1970)						
Fuse (Recommended)		6	10	20	6	10	20	A
Type of connection		spring-type terminal included with plug						
Noise level (according to EN ISO 3741)		< 62					dB(A)	
Weight (without packaging)		112 (51)	101 (46)	97 (44)	111 (50.5)	99 (45)	88 (40)	lb (kg)
Ambient temperature range		+ 59 ... + 131 / + 15 ... + 55					°F / °C	
Control range (adjustable)	SC	+ 77 ... + 113 / + 25 ... + 45 ; factory setting + 95 / + 35						
Refrigerant	type	R134a						
	quantity	750			725		g	
Duty cycle		100%						
Condensate management		integrated condensate evaporation system with safety overflow						
Protection system according to EN 60529		NEMA 12 against enclosure when properly installed						
		NEMA 1 towards the surroundings when properly installed						
Design	housing	galvanized sheet steel						
	cover	galvanized/electrostatically powder coated (200 °C)						

Accessories	Piece	Part number	Information on page
Fluted Filter	1	18611600037	94
Condensate bottle	1	18314000100	94

Approvals see page 11/12

Cooling Capacity Performance Curve

DTT 6401

DTT 6301

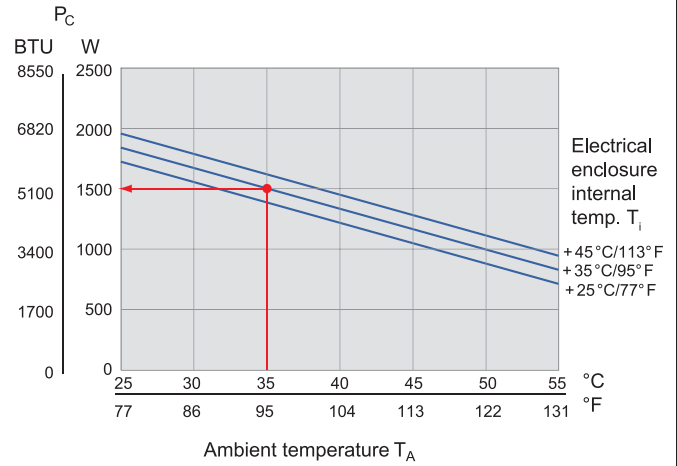
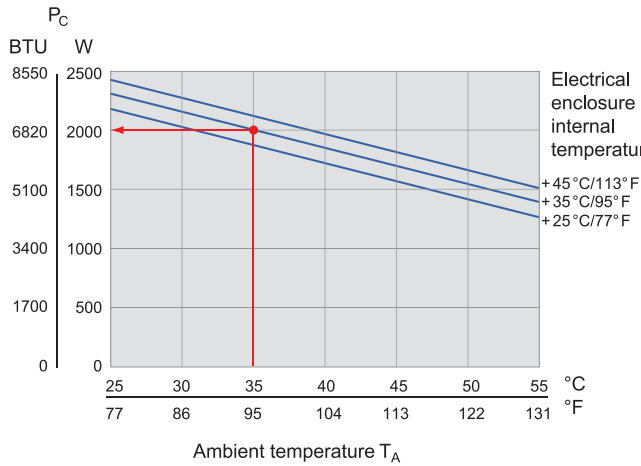

How to use chart

Example:
@ 95° F (ambient, X-axis), @ 95° F (internal, diagonal lines)
= 6820 (DTT 6401) or 5100 (DTT 6301) Btu/h cooling capacity (Y-axis)

Dimensions

DTT 6401 / DTT 6301

Dimension	inches (mm)
X	23.4 (595)
Y	17.1 (435)
Z	19.5 (495)
A	15.6 (395)
B	19.5 (495)

For exact cutout information reference drilling template at pfannenbergusa.com

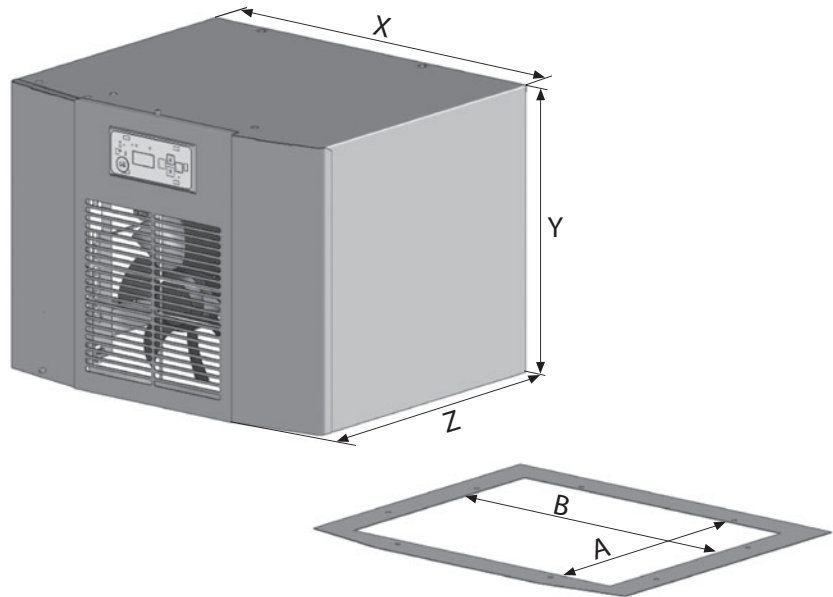

DTT 6601

Top Mounted Cooling Unit 7000 - 10000 Btu/h

DTT 6801

Top mounted Cooling Unit 12000 - 14000 Btu/h

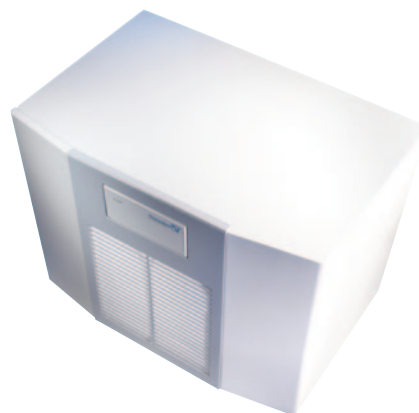

- Product variety: 3 installation sizes and 6 performances
- 4-fold protection against condensate with patented condensate management system
- Toolless mounting and maintenance due to quick-release mounting frame
- Service-friendly: complete cover removable towards the front. Easily accessible filter mats and control elements in front area.
- Energy efficiency: around 20 % saving on energy thanks to the use of more effective, lighter components
- UL certification
- Design and color matching: perfect mixture of functionality and design

Data	DTT 6801	DTT 6601	Unit
Part number RAL 7035 (Light Gray)	13216832055	13216632055	
Rated voltage ± 10 %	400 / 460 3Ø	400 / 460 3Ø	V
Frequency	50 / 60		Hz
Cooling performance according to EN 14511	12000 - 14000	7000 - 10000	Btu/h
Power consumption	1618 / 2050	1700 / 2100	W
Nominal (Run) Current	3.4 / 3.5	2.45 / 2.49	A
Starting current	17.1 / 19.5	8.9 / 9.9	
Unimpeded airflow (free flow)	internal	836 - 900 (1420 / 1530)	
	external	1159 - 1283 (1970 / 2180)	
Fuse (Recommended)	10	10	A
Type of connection	spring-type terminal included with plug		
Noise level (according to EN ISO 3741)	< 62		
Weight (without packaging)	170 (77)	165 (75)	lb (kg)
Ambient temperature range	+ 59 ... + 131 / + 15 ... + 55		
Control range (adjustable)	SC	+ 77 ... + 113 / + 25 ... + 45 ; factory setting + 95 / + 35	
Refrigerant	type	R134a	
	quantity	1500	1350
Duty cycle	100%		
Condensate management	integrated condensate evaporation system with safety overflow		
Protection system according to EN 60529	NEMA 12 against enclosure when properly installed		
	NEMA 1 towards the surroundings when properly installed		
Design	housing	galvanized sheet steel	
	cover	galvanized/electrostatically powder coated (200 °C)	

Accessories	Piece	Part number	Information on page
Fluted Filter	1	18611600037	94
Condensate bottle	1	18314000100	94

Approvals see page 11/12

Cooling Capacity Performance Curve

DTT 6801

DTT 6601

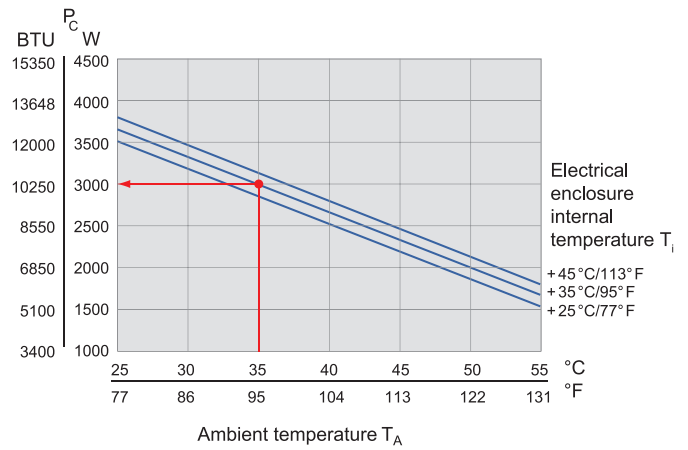
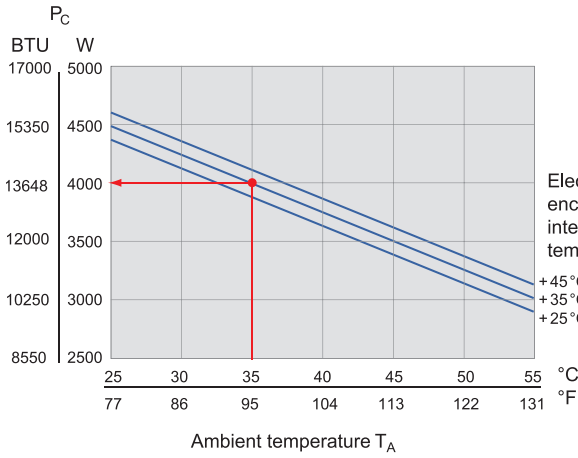

How to use chart

Example:
@ 95° F (ambient, X-axis), @ 95° F (internal, diagonal lines)
= 13648 (DTT 6801) or 10250 (DTT 6601) Btu/h cooling capacity (Y-axis)

Dimensions

DTT 6801 / DTT 6601

Dimension	inches (mm)
X	31.3 (795)
Y	19.1 (485)
Z	22.6 (575)
A	15.4 (392)
B	27.2 (692)

For exact cutout information reference drilling template at pfannenbergusa.com

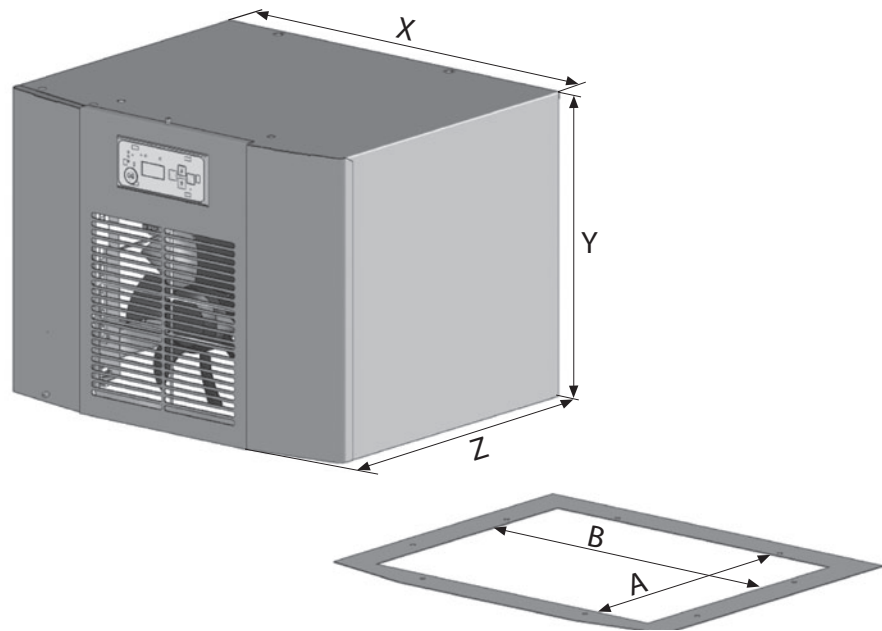

Other products and literature available from Pfannenberg...

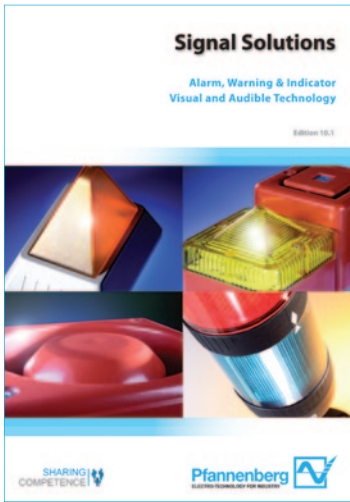

Signal Solutions Guide

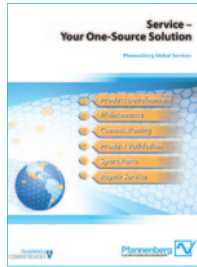

Global Service Guide



DTT Series Cooling Units



Wind Energy Solutions Guide



Food & Beverage Thermal Management Solutions

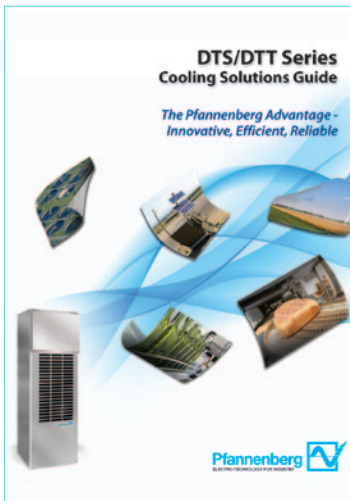

Cooling Solutions Guide

A Bright Idea!
*Building, Landmark & Art Illumination
by Pfannenberg*

Durable weather-resistant design and long service life make Pfannenberg lighting systems the optimal choice.

Call today for more information!

*TV Tower & Trinity Bridge,
St. Petersburg, Russia*

*Eiffel Tower,
Paris, France*



Pfannenberg Incorporated
68 Ward Road
Lancaster, New York 14086 USA
Phone: 716-685-6866
Fax: 716-681-1521

info@pfannenbergusa.com
www.pfannenbergusa.com



Subject to technical amendments and misprints.